



Co-funded by the European Union



Norwegian Embassy
Islamabad



© TVET SSP

POST PRESS OPERATIONS (Publishing)

Learner Guide

National Vocational Certificate Level 5

Version 1 - December 2019



Implemented by

giz Deutsche Gesellschaft
für Internationale
Zusammenarbeit (GIZ) GmbH

Published by

National Vocational and Technical Training Commission
Government of Pakistan

Headquarter

Plot 38, Kirthar Road, Sector H-9/4, Islamabad, Pakistan
www.navttc.org

Responsible

Director General Skills Standard and Curricula, National Vocational and Technical Training Commission
National Deputy Head, TVET Sector Support Programme, Deutsche Gesellschaft für Internationale Zusammenarbeit (GIZ) GmbH

Layout & design

SAP Communications

Photo Credits

TVET Sector Support Programme

URL links

Responsibility for the content of external websites linked in this publication always lies with their respective publishers. TVET Sector Support Programme expressly dissociates itself from such content.

This document has been produced with the technical assistance of the TVET Sector Support Programme, which is funded by the European Union, the Federal Republic of Germany and the Royal Norwegian Embassy and has been commissioned by the German Federal Ministry for Economic Cooperation and Development (BMZ). The Deutsche Gesellschaft für Internationale Zusammenarbeit (GIZ) GmbH in close collaboration with the National Vocational and Technical Training Commission (NAVTTTC) as well as provincial Technical Education and Vocational Training Authorities (TEVTAs), Punjab Vocational Training Council (PVTC), Qualification Awarding Bodies (QABs)s and private sector organizations.

Document Version

December, 2019
Islamabad, Pakistan

POST PRESS OPERATIONS (Publishing)

Learner Guide

National Vocational
Certificate Level 5

Version 1 - December 2019

Introduction:

This Learner's Guide is developed on the basis of competency standards and curriculum of "Post Press Operations".

The National Vocational & Technical Training Commission (NAVTTTC) has developed a national qualification entitled, "National Vocational Certificate Level-5 in Post press Operations (Incharge Post Press operations)". Relevant industry and employers were consulted in the design and validation processes in order to come up with a national qualification that fulfills the requirements of the sector in general and the occupation in particular.

This book covers all the topics in a clear and organized format for the Post Press students. Through learning outcomes practical activities were added step by steps. The topics covered were neatly illustrated for better understanding of the learners. All of the lesson pages were carefully designed to eliminate distraction and to focus the pupil's full attention on the work at hand.

It carries 12 learning modules which are as under:

- Module .1 Perform quality inspection
- Module .2 Develop entrepreneur skills
- Module .3 Manage a team
- Module .4 Plan business activities
- Module .5 Address Basic Customer needs
- Module .6 Manage Human Resources
- Module .7 Manage Personal Finance
- Module .8 Solve Problems pertaining to health and safety
- Module .9 Develop Business Plan
- Module .10 Apply Information and Communication Skills
- Module .11 Perform color management
- Module .12 Develop Layout and dummy

POST PRESS OPERATIONS (Publishing)

Learner Guide

National Vocational
Certificate Level 5

Version 1 - December 2019

Module-1

Module 1: - Perform Quality Inspection

Learning Unit:

After completion of this module the learner will be able to:

- LU1: Carryout Printing Inspection
- LU2: Carryout Publishing Inspection
- LU3: Carryout Packaging Inspection
- LU4: Maintain Test record

Learning Unit - 1:

Carryout Printing inspection

Overview: The purpose of this learning unit is to inform the learner about carrying out printing inspection, checking first final printed sheet for approval, verify registration, side-lay, front-lay, folding marks, color variation using L*a*b*, content on printed sheet, grain direction and Gram per square meter.

The student will learn to use: GSM cutter, Micrometer, Measuring scale, Weighing scale, Spectro -densitometer

Define knowledge of substrate

Term for any surface to be printed to which ink will adhere. The substrate, also called stock, is typically paper, but can also refer to plastics, foil, metal, cloth, or any other surface to which printing ink will be applied.

There are 2 basic types of paper:

Virgin paper: is sourced from wood, molasses and various other sources

Mixed paper: is made by mixing virgin pulp with de-inked paper

Understand the purpose of quality control

What is Quality Control?

From the buyer's perspective, quality control activities help confirm that a batch of products meet specifications. The most common activity is the final inspection, which means checking some products against a checklist, and getting to a pass/fail result.

The 3 Fundamental QC Concepts:

If you have not started doing professional quality control, you will need to understand these 3 concepts to make sure the QC inspection plan meets your needs and that you obtain products which reach your expectations from your suppliers in Asia.

- Inspection levels
- The AQL (Acceptance Quality Limit)
- When to inspect?

Purpose of quality control:

Quality control involves testing of units and determining if they are within the specifications for the final product. The purpose of the testing is to determine any needs for corrective actions in the manufacturing process. Good quality control helps companies meet consumer demands for better products.

Define importance of grain direction:**Paper Grain Direction**

The grain in paper comes from how the fibers of the paper are arranged. The fibers are typically parallel to each other across the sheet and knowing the grain direction is important when we go to fold the sheet of paper.

If we fold against the grain, it will be difficult to fold or it will be stiffer to fold and then the fibers crack and we get an uneven or rough fold and the fold won't be as clean or flat as we might want. Going parallel to the grain reduces the cracking and we get a smooth, flat fold.

How to determine the grain

With thinner papers it is harder to tell the grain direction, heavier papers are more obvious and easier to determine.

Three quick tests to check for grain direction

1) Tear Test – Take a sheet of paper and tear it horizontally and then vertically. One tear should have been straighter than the other. The tear that was straighter is parallel to the grain, the jagged tear is going across the grain.

2) Bend Test – Take a sheet of paper, bend the paper (don't fold or crease it) horizontally and vertically. There will be less resistance in one direction than the other. The bend with less resistance is parallel to the grain.

3) Fingernail Test – Take a sheet of paper and using the fingernails of your thumb and middle finger pinch the paper and slide them across and then down the paper. One direction should produce a "wave", the wave indicates that you went across the grain.





Short Grain – The grain runs parallel to the short edge of the paper.

Long Grain – The grain runs parallel to the long edge of the paper.

Practical Activity # 1

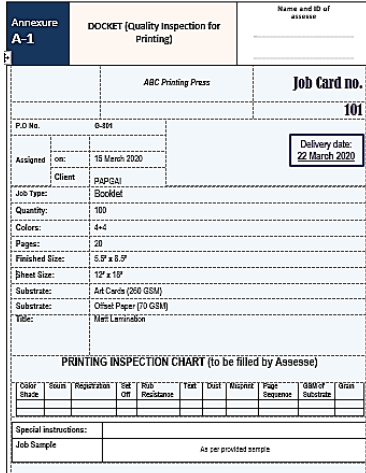
Verify printed material from docket

Perform Quality Inspection	
Module: 1	Learning Unit: 1
	Carryout Printing inspection
Practical Description:	Verify the printed material from docket before post-press operation as per press SOP's
Time:	40 Hours
Equipment	Weighing scale Spectro -densitometer
Tools	Micrometer Measuring scale Vernier caliper GSM cutter
PPE	Gloves
Materials	Printed Paper
Key Point	Acceptance levels as per job requirement
Learning Outcome:	<ul style="list-style-type: none"> • Check first final printed sheet for approval. • Verify printed sheet registration. • Verify side-lay and front-lay. • Verify folding marks. • Verify Color variation. • Check dot gain and density • Verify content on printed sheet. • Verify grain direction. • Verify GSM (Gram per Square Meter) / thickness of the substrate. • Proof read the sheet
Precautions:	Instrument should be well calibrated
Instructions	Illustrations

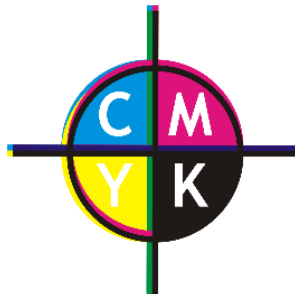
<p>1. Read docket carefully for post-press operation instructions</p>	
<p>2. Inspect dummy carefully</p>	
<p>3. Collect a final printed sheet before post-press operation and proof read the sheet.</p>	
<p>4. Use GSM cutter to cut out round piece of printed paper and place the cut out piece on weighing scale and compare the result with docket</p>	
<p>5. Verify registration mark, color bar, cutting marks, bleed area, perforation marks (if any), and folding marks from dummy</p> <p>6. check the dot gain and density</p>	

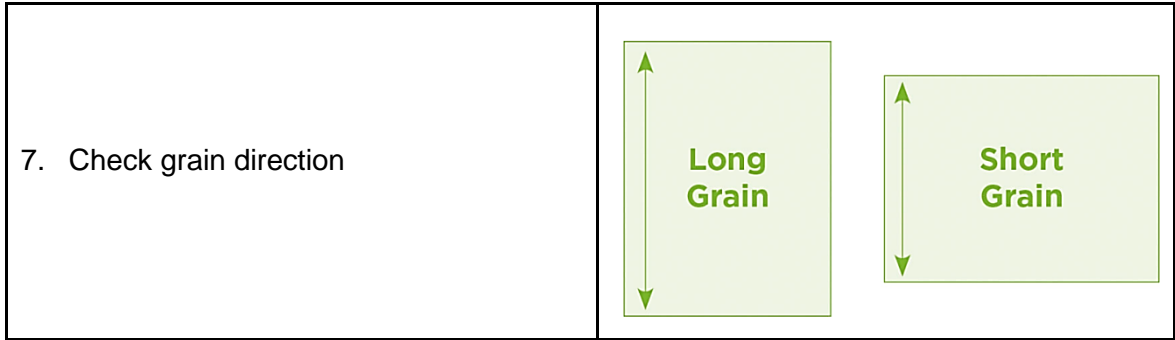

Learning Unit - 2:

Carryout Publishing inspection

Overview: The purpose of this learning unit is to inform the learner about understanding the application of measuring instrument used in printing.

Understand the use of measuring instrument

Measuring instruments are used to verify different types of book binding in post-press operations. There are 4 types of book binding.

1. HARD COVER BINDING

The inside pages are sewn together in sections. The sections are then glued to the endpapers which are finally glued to the cover's spine. When opened, case bound books lay flat on the table.

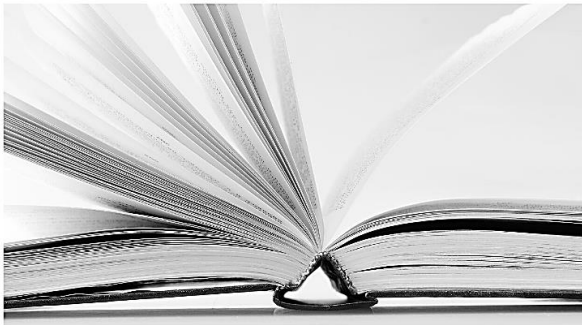

2. PERFECT BINDING

Perfect binding (also known as soft cover binding) is similar to case binding, except for the lower quality cover. A perfect binding cover is made from heavy weight cardstock paper that is often coated or laminated to protect the book. With this type of binding, the cover and pages are glued together with a hot or cold glue. Often the cover is longer than the pages, so the cover is trimmed to give it that perfect look.

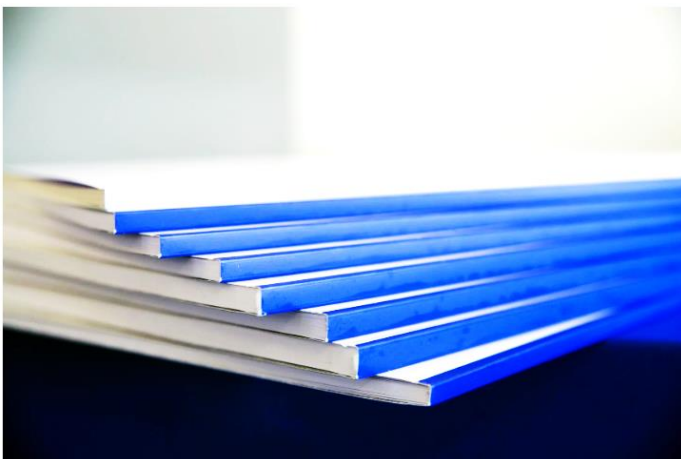

3. SADDLE STITCH BINDING

Once pages are printed and organized, they are stacked and loaded onto a conveyor from where they are stitched together using metal staples. Stitching can be done with or without a book cover.



4. COMB, SPIRAL & THERMAL BINDING

These are the three techniques commonly used when binding short-run books. Comb binds actually look like a comb threading into a series of holes punched into the edge of the book. Spiral binding involves punching of similar holes but instead of the comb, a metal/plastic coil is threaded through the holes. Thermal binding is a bit different; the pages of the book are glued to the spine by heating the cover's spine.



Gathering and Collating

In printing, the term Collate refers to the gathering and arranging of individual sheets or other printed components into a pre-determined sequence. Basically, Collating creates consistent, logical sets from multiple parts.

Diagram A illustrates four sets of documents which have been collated. Diagram B illustrates four sets of documents which have not been collated.

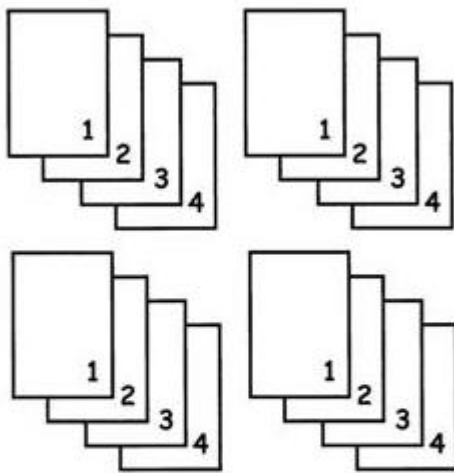

Diagram A - Collated sets of documents

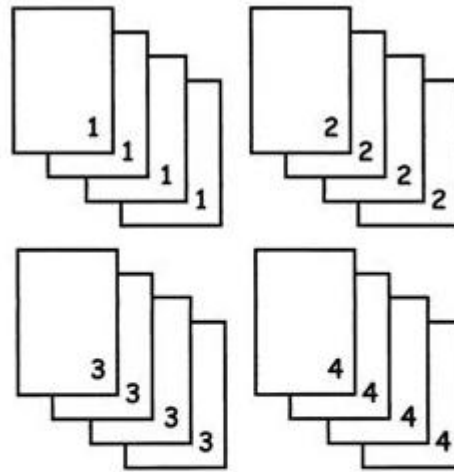

Diagram B - Uncollated sets of documents

Roman Number Chart

Roman Numeral Chart 1 to 20 - nicholasacademy.com				
I = 1	V = 5	X = 10		
I	II	III	IV	V
1	2	3	4	5
VI	VII	VIII	IX	X
6	7	8	9	10
XI	XII	XIII	XIV	XV
11	12	13	14	15
XVI	XVII	XVIII	XIX	XX
16	17	18	19	20

Creasing

Looking at the mechanics of a crease we can see why this works. A creased piece of cover stock *appears* to be one fold but a close-up reveals two smaller hinge points, on either side of the creased bead, as shown in Figure 1. The method here takes advantage of that fact.



Creasing perfect bound book covers is difficult when the spine thickness approaches 1/8" and under. It's not hard to see why when you look at the components involved. There are simply physical limitations to how closely 2 creasing rules can be placed, even using thinner 1 pt creasing rule along with special double-crease female matrix. Rotary creasing also faces similar limitations.



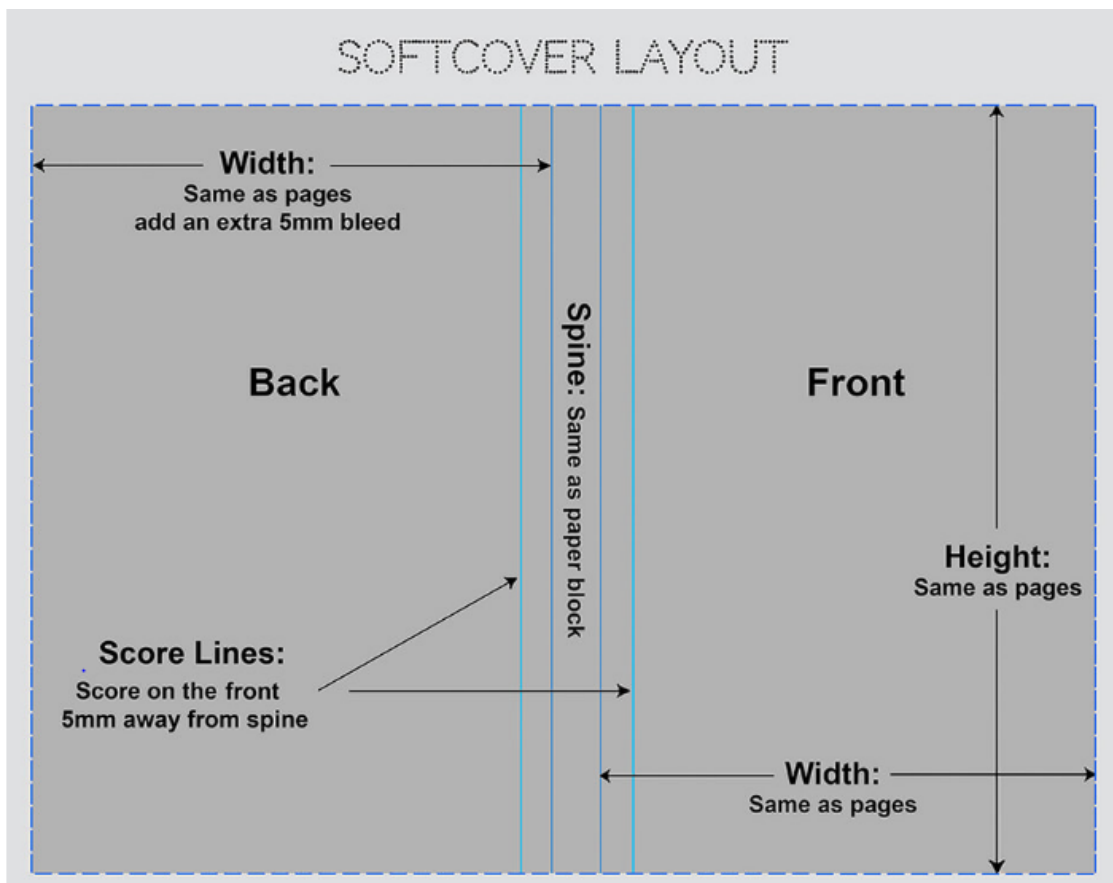

When needing two closely spaced creases, whether for book covers or other types of folded pieces, try this common workaround: substitute one wide score. And if possible, use a thinner caliper stock.

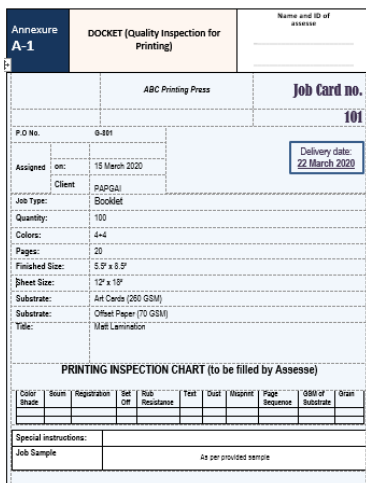

Practical Activity # 2

Verify post-printed material from docket

Perform Quality Inspection		
Module: 1	Learning Unit: 2	Carryout Publishing Inspection
	Practical Description:	Verify the post-printed material from docket after post-press operation as per press SOP's
Time:	65 Hours	
Equipment	n/a	
Tools	Measuring scale Vernier caliper	
PPE	Gloves	
Materials	Post-press product	
Key Point	Acceptance levels as per job requirement	
Learning Outcome:	<ul style="list-style-type: none"> • Check form series. • Check page sequence. • Check folding as per mark. • Check gathering sequence. • Check saddle stitch / thread swing. • Verify hot glue binding. • Verify title creasing • Verify Title lamination. • Verify Book trimming. 	
Precautions:	Environment should be well lit	
Instructions		Illustrations

<p>1. Read docket carefully for post-press operation instructions</p>	 <p>Annexure A-1 DOCKET (Quality Inspection for Printing) Name and ID of assesse</p> <p>ABC Printing Press Job Card no. 101</p> <p>P.O No. 0-001</p> <p>Assigned on: 15 March 2020 Delivery date: 22 March 2020</p> <p>Client: PAPQA Job Type: Booklet</p> <p>Quantity: 100 Colors: 4+4</p> <p>Pages: 20 Finished Size: 5.5" x 8.5"</p> <p>Sheet Size: 12" x 19" Substrate: Art Cards (250 GSM)</p> <p>Substrate: Offset Paper (70 GSM) Title: Matt Lamination</p> <p>PRINTING INSPECTION CHART (to be filled by Assesse)</p> <table border="1"> <thead> <tr> <th>Color Shade</th> <th>Sour</th> <th>Registration</th> <th>Set Off</th> <th>Rob. Resistance</th> <th>Text</th> <th>Dist</th> <th>Misprint</th> <th>Page Sequence</th> <th>GSM of Substrate</th> <th>Grain</th> </tr> </thead> <tbody> <tr> <td></td> <td></td> <td></td> <td></td> <td></td> <td></td> <td></td> <td></td> <td></td> <td></td> <td></td> </tr> </tbody> </table> <p>Special instructions: Job Sample As per provided sample</p>	Color Shade	Sour	Registration	Set Off	Rob. Resistance	Text	Dist	Misprint	Page Sequence	GSM of Substrate	Grain											
Color Shade	Sour	Registration	Set Off	Rob. Resistance	Text	Dist	Misprint	Page Sequence	GSM of Substrate	Grain													
<p>2. Inspect dummy carefully</p>																							
<p>3. Collect a final product sample from post-press workstation</p>																							
<p>4. Verify registration, color variance, cutting size, bleeding, perforation (if any), and folding from dummy</p>																							

5. Check hot glue binding/ saddle stitch binding/ thread binding



6. Verify type and application of lamination on title



Learning Unit - 3:

Carryout Packaging Inspection

Overview: The purpose of this learning unit is to inform the learner about inspection of packaging material.

Describe types of glue

The three main types of packaging adhesives are water-based, solvent-based and hot-melt adhesives. Of these, water-based and hot-melt systems are gradually edging out solvent-based systems as adhesive manufacturers strive to reduce volatile organic compound (VOC) emissions and improve air quality.

For packaging applications, water-based adhesives are the most widely used. In addition to air-quality benefits, water-based adhesives offer the advantages of strength, low cost, energy efficiency, ease of use and safety. Water-based adhesives are available in both natural and synthetic variants. Natural ingredients include animal- and vegetable-derived materials like starch and animal glue.

Synthetic water-based adhesives are used—increasingly in place of natural water-based adhesives—to label containers, make composite cans and form and seal cartons and cases.

Use of hot-melt adhesives for packaging applications continues to grow, primarily for automated carton and case sealing. This type of adhesive is 100 percent solid; it contains no solvent or water. On the packaging line, a dispensing system applies the adhesive to a substrate such as paperboard, rigid polyethylene or film-laminated material. The hot-melt adhesive dries quickly after application, forming a strong bond between the joined surfaces.

Because hot-melt adhesives dry so quickly, they are most suitable for high-speed operations. This type of adhesive also can be formulated for use with a range of packaging materials, though any substrate that is sensitive to heat is a poor candidate. Processes that expose the hot-melt bond to high temperatures also are not appropriate, as the heat can cause the adhesive to melt and the bond to fail.

Die cutting operation

Die cutting generally uses traditional machines that may be up to a century old. Steel cutting, creasing and perforating rules, secured in a wooden block, are used to cut or crease a substrate into a particular shape, using pressure.

Used for cutting out boxes, folders, and pockets, creasing more complex folds, or perforating, Die Cutting can help to create many special shapes, curved edges, or bespoke apertures. We are also able to Kiss Cut or Die Cut partially through a substrate, which is great for self-adhesive labels when required on a sheet. Really intricate shapes require Laser Cutting or use of a Flexo Die.

Die cutting typically refers to the cutting action of a die press. When a die is pressed into a material such as folding carton board or corrugated board for packaging or leather for making shoes it cuts the material into the shape outlined by the die.

It can also refer to the process of making the die itself. Die-cutting tooling is fundamentally a combination of wood, steel blade and rubber prepared into a specific shape and structure to enable compression of substrate materials and hence forming of specific shapes – mainly boxes.

In this process of die manufacturing the skill of the technician in forming the die is paramount. High tech laser cutting systems are used to create the precision cut into the plywood backing but accurate bending, shaping and preparing the steel rule is of paramount importance.

'Knifing' the die can also involve preparing a variety of complex cut types and patterns to be made such as scoring, tear-strips etc. Scoring can be further used to create a number of complex functions such as tamper-proof seals which have become important in the packaging industry.

Creasing is also incorporated into the die to produce the fold positions of boxes and cartons. Rather than crease the products on a separate machine after the cuts have been made, creasing them in the cutting phase means they are usually more accurate and this facilitates high speed gluing and better performance on automatic packing lines.

The design of the die outline requires a lot of experience and knowledge also. A 2 dimensional drawing and tool have to be visualized as a 3 dimensional end product.

Computer Aided Design programs make this task a little easier than it would have been previously.

Computer modelling can also make improvements in efficiency, producing less cut-off and waste. This provides substantial savings for the producer over time as die cutting runs reach into six, seven and eight figure numbers. There is a double saving in the form of various national and international directives on waste that require a manufacturer to pay in advance for any products they produce that will ultimately need to be recycled.

Pasting operation

Overview:

This learning unit describes the procedure of the pasting operation.

Describe purpose of Pre-glue station: The purpose of pre-glue station is turning of glue flap and 3rd fold.

Describe purpose of glue pot station: The purpose of glue pot station is to apply glue on gluing flap of every skillet

Describe purpose of Post-glue station: The purpose of post-glue station is to crease fold 2nd and 4th

Describe purpose of Delivery station: The purpose of delivery station is to press the cartons under blankets for pressure.



Describe the importance of glue position on glue flap: The importance of glue position on glue flap is to bind the cartons together.

Practical Activity # 3



Verify packaging from docket

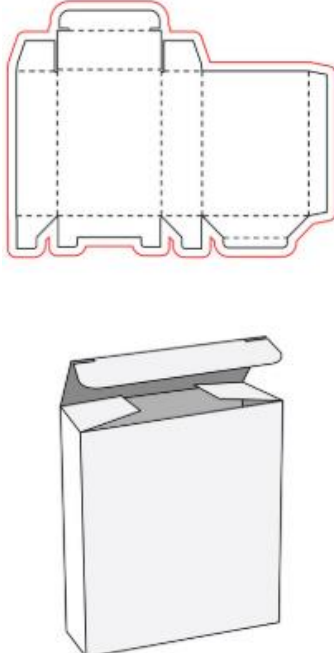

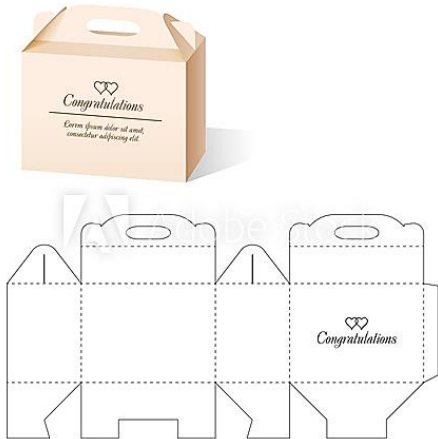
Perform Quality Inspection	
Module: 1	Learning Unit: 3
	Carryout Packaging Inspection
	Practical Description: Verify the completed post-press material as per press SOP's
Time:	65 Hours
Equipment	Paper/board moisture meter Humidity meter
Tools	Magnifying glass Creasing Matrix chart Din/viscosity cup
PPE	Gloves Dust mask Safety Goggles
Materials	Final product
Key Point	Acceptance levels as per job requirement
Learning Outcome:	<ul style="list-style-type: none"> • Verify die cutting pressure of substrate. • Verify cutting and embossing registration / position. • Verify embossing impression. • Verify Box alignment. • Verify perforation and creasing impression. • Verify lock alignment. • Verify lamination / coating. • Verify Pasting strength. • Verify folded crease quality. • Verify glue viscosity. • Verify cutting test of skillet/unit box. • Verify grain direction as per approved sample. • Verify perforation test (tear test/light passing method) as per

	<p>instruction</p> <ul style="list-style-type: none"> Verify foiling impression as per approved sample.
<p>Precautions:</p>	<p>Ensure proper lighting at workplace Ensure proper calibration of equipment</p>
<p>Instructions</p>	<p>Illustrations</p>
<p>1. Check docket for job description</p>	
<p>2. List down check points to be verified</p>	

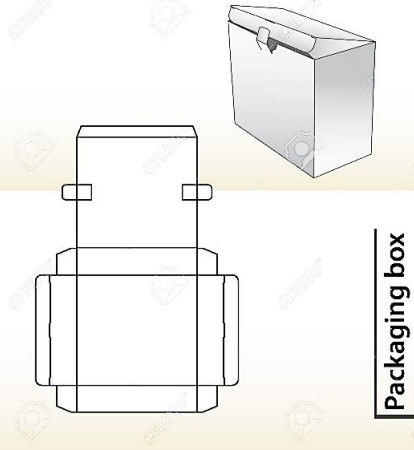
<p>3. Verify die cutting edges and crease on substrate</p>	 <p>The image shows a die cut template for a box with a top flap, outlined in red. Below it is a 3D perspective view of the assembled box, which is a simple rectangular box with a top flap.</p>
<p>4. Verify cutting and embossing registration / position</p>	 <p>A close-up photograph of a white card with embossed text in a cursive font. The text reads: "lindsay and august invite you to celebrate their wedding on the twentieth of June 20th 2009". The card is being held by a white ribbon.</p>
<p>5. Verify Box interlock alignment</p>	 <p>The image shows a 3D perspective view of a brown cardboard box with a top flap. The box has the word "Congratulations" and a small heart icon embossed on it. Below the box is a die cut template for the box, showing the interlock alignment of the flaps. The template also has the word "Congratulations" and a small heart icon on one of the side panels.</p>

#198753506

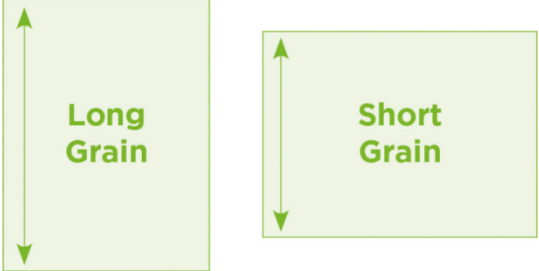
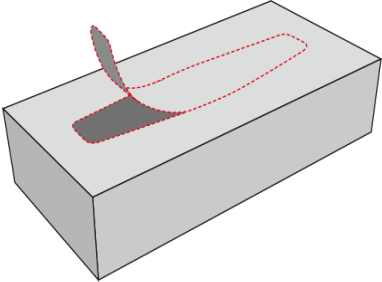
6. Verify Box shape	 <p>Packaging box</p>
7. Verify lamination / coating	
8. Verify Pasting strength	
9. Verify glue viscosity	N/A

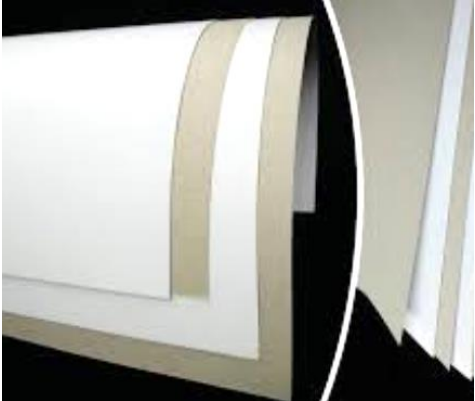
<p>10. Verify grain direction as per approved sample</p>	
<p>11. Verify perforation test (tear test/light passing method) as per instruction</p>	
<p>12. Verify foiling impression as per approved sample</p>	
<p>13. Verify moisture value of board delete</p>	

14. Check humidity level in the workplace



Learning Unit - 4:

Maintain Test record

Overview: The purpose of this learning unit is to inform the learner to maintain test record.

How to fill quality check list

A quality control checklist goes by many names—an inspection criteria sheet (ICS), a QC checklist, a quality assurance checklist or quality control sheet. All these names refer to a document that outlines quality requirements and specifications in a clear and concise manner for your supplier.

Inspection checklists are one of the simplest, yet most effective, ways to clarify requirements and prevent defects in your goods.

Quality control inspection checklists serve two main purposes:

Outline quality standards and product requirements the supplier is expected to meet and

Provide objective criteria for inspecting the product to ensure it meets customer's expectations

It's helpful to share a detailed quality assurance checklist with your supplier, even before starting production. This gives the supplier an opportunity to review your requirements and notify you if any are unreasonable or need adjusting before mass production.

A QC checklist would likely prevent the dimensional issues in the keychain example used earlier, since a checklist typically specifies dimensional tolerances and measuring methods. Your supplier can refer to this document, along with an approved sample, to understand your requirements throughout production.

When it comes to checking the product before shipment, the quality control checklist should provide the standard for inspection as well. The checklist is not only helpful for internal QC staff checking the product, but also essential for you or any third-party inspector you hire to inspect on your behalf.

A QC checklist typically includes a section which defines the market of sale and regulations or standards the product must meet.

Because regulatory requirements differ by country, you might also consider creating different checklist templates for different markets—even for the same products.

In this way, quality assurance checklists can help clarify to the manufacturer what regulatory requirements the product needs to meet, especially if you're exporting to multiple markets.

Your quality control sheet needs to be direct and written in a clear format. Remember you aren't the only one reading your quality control sheet. Your supplier and any third-party inspector you hire also need to be able to easily interpret it.

It may also be helpful to have the document translated into the native language.

Practical Activity # 4

Observe and fill logbook as per SOP's

Perform Quality Inspection																																																																																										
Module: 1	Learning Unit: 4	Maintain Test record																																																																																								
	Practical Description:	Fill the logbook for various post-press procedures as per SOP's																																																																																								
Time:	25 Hours																																																																																									
Equipment	n/a																																																																																									
Tools	Log book																																																																																									
PPE	n/a																																																																																									
Materials	n/a																																																																																									
Key Point	Read form thoroughly before filing																																																																																									
Learning Outcome:	<ul style="list-style-type: none"> Record Physical Publishing Inspection test results Record Physical Packaging Inspection test results 																																																																																									
Precautions:	Ensure proper lighting at workplace Avoid over writing																																																																																									
Instructions	Illustrations																																																																																									
1. Check docket for job description	<table border="1" style="width: 100%; border-collapse: collapse;"> <thead> <tr> <th style="background-color: #003366; color: white;">Annexure A-2</th> <th style="background-color: #FFDAB9;">DOCKET (Quality Inspection for Publishing)</th> <th style="font-size: small;">Name and ID of assesse</th> </tr> </thead> <tbody> <tr> <td colspan="2" style="text-align: center;">ABC Printing Press</td> <td style="text-align: right;">Job Card no.</td> </tr> <tr> <td colspan="2"></td> <td style="text-align: right;">101</td> </tr> <tr> <td style="font-size: x-small;">P.O No.</td> <td style="font-size: x-small;">G-302</td> <td></td> </tr> <tr> <td style="font-size: x-small;">Assigned on:</td> <td style="font-size: x-small;">15 March 2020</td> <td style="border: 1px solid blue; padding: 2px;">Delivery date: 22 March 2020</td> </tr> <tr> <td style="font-size: x-small;">Client</td> <td style="font-size: x-small;">PAPGAJ</td> <td></td> </tr> <tr> <td style="font-size: x-small;">Job Type:</td> <td style="font-size: x-small;">Booklet</td> <td></td> </tr> <tr> <td style="font-size: x-small;">Quantity:</td> <td style="font-size: x-small;">100</td> <td></td> </tr> <tr> <td style="font-size: x-small;">Colors:</td> <td style="font-size: x-small;">4-4</td> <td></td> </tr> <tr> <td style="font-size: x-small;">Pages:</td> <td style="font-size: x-small;">20</td> <td></td> </tr> <tr> <td style="font-size: x-small;">Finished Size:</td> <td style="font-size: x-small;">5.5" x 8.5"</td> <td></td> </tr> <tr> <td style="font-size: x-small;">Sheet Size:</td> <td style="font-size: x-small;">12" x 18"</td> <td></td> </tr> <tr> <td style="font-size: x-small;">Substrate:</td> <td style="font-size: x-small;">Art Cards (250 GSM)</td> <td></td> </tr> <tr> <td style="font-size: x-small;">Substrate:</td> <td style="font-size: x-small;">Offset Paper (70 GSM)</td> <td></td> </tr> <tr> <td style="font-size: x-small;">Binding Type:</td> <td style="font-size: x-small;">Saddle stitch</td> <td></td> </tr> <tr> <td colspan="3" style="text-align: center;">PUBLISHING INSPECTION CHART (to be filled by Assesse)</td> </tr> <tr> <td style="font-size: x-small;">Folio</td> <td style="font-size: x-small;">Folding Check</td> <td style="font-size: x-small;">Splicing Check</td> <td style="font-size: x-small;">File Alignment</td> <td style="font-size: x-small;">Binding Strength</td> <td style="font-size: x-small;">Lamination Check</td> <td style="font-size: x-small;">Crease Check</td> <td style="font-size: x-small;">Wire Check</td> <td style="font-size: x-small;">Trimming Check</td> <td style="font-size: x-small;">Size Check</td> </tr> <tr> <td></td> <td></td> <td></td> <td></td> <td></td> <td></td> <td></td> <td></td> <td></td> <td></td> </tr> <tr> <td colspan="2" style="font-size: x-small;">Special instructions:</td> <td colspan="8"></td> </tr> <tr> <td colspan="2" style="font-size: x-small;">Job Sample</td> <td colspan="8" style="text-align: center; font-size: x-small;">As per provided sample</td> </tr> </tbody> </table>		Annexure A-2	DOCKET (Quality Inspection for Publishing)	Name and ID of assesse	ABC Printing Press		Job Card no.			101	P.O No.	G-302		Assigned on:	15 March 2020	Delivery date: 22 March 2020	Client	PAPGAJ		Job Type:	Booklet		Quantity:	100		Colors:	4-4		Pages:	20		Finished Size:	5.5" x 8.5"		Sheet Size:	12" x 18"		Substrate:	Art Cards (250 GSM)		Substrate:	Offset Paper (70 GSM)		Binding Type:	Saddle stitch		PUBLISHING INSPECTION CHART (to be filled by Assesse)			Folio	Folding Check	Splicing Check	File Alignment	Binding Strength	Lamination Check	Crease Check	Wire Check	Trimming Check	Size Check											Special instructions:										Job Sample		As per provided sample							
Annexure A-2	DOCKET (Quality Inspection for Publishing)	Name and ID of assesse																																																																																								
ABC Printing Press		Job Card no.																																																																																								
		101																																																																																								
P.O No.	G-302																																																																																									
Assigned on:	15 March 2020	Delivery date: 22 March 2020																																																																																								
Client	PAPGAJ																																																																																									
Job Type:	Booklet																																																																																									
Quantity:	100																																																																																									
Colors:	4-4																																																																																									
Pages:	20																																																																																									
Finished Size:	5.5" x 8.5"																																																																																									
Sheet Size:	12" x 18"																																																																																									
Substrate:	Art Cards (250 GSM)																																																																																									
Substrate:	Offset Paper (70 GSM)																																																																																									
Binding Type:	Saddle stitch																																																																																									
PUBLISHING INSPECTION CHART (to be filled by Assesse)																																																																																										
Folio	Folding Check	Splicing Check	File Alignment	Binding Strength	Lamination Check	Crease Check	Wire Check	Trimming Check	Size Check																																																																																	
Special instructions:																																																																																										
Job Sample		As per provided sample																																																																																								

2. Fill out the following check list after observing the sample



PRINTING INSPECTION CHART (to be filled by Assesse)

Color Shade	Scum	Registration	Set Off	Rub Resistance	Text	Dust	Misprint	Page Sequence	GSM of Substrate	Grain

Special instructions:	
Job Sample	As per provided sample

Summary of the Module

- The substrate, also called stock, is typically paper, but can also refer to plastics, foil, metal, cloth, or any other surface to which printing ink will be applied.
- There are 2 basic types of paper:
 - Virgin paper
 - Mixed paper
- Quality control activities help confirm that a batch of products meet specifications.
- 3 Fundamental QC Concepts
- The grain in paper comes from how the fibers of the paper are arranged.
- Measuring instruments are used to verify different types of book binding in post-press operations. There are 4 types of book binding.
- The three main types of packaging adhesives are water-based, solvent-based and hot-melt adhesives.

Frequently Asked Questions (FAQs)

Question	Answer
1. What are the sources of virgin paper?	Virgin paper is made of virgin pulp. Pulp can be extracted from many sources; wood, molasses etc.
2. Why do we need to check quality of printed matter in post-press?	It is imperative that the printing is correct so that post-press operations can be carried out properly.
3. When should we inspect the material?	Post-press material is inspected at all stages; when receiving from press, during operation and after finishing operation
4. What will happen when short grain is folded?	Folding on short grain can lead to cracking on the edges.
5. What is the difference between spectrophotometer and Spectro densitometer?	Both are same.
6. What is the maximum thickness of the book for perfect binding?	Depending on the substrate and perfect binding machine type; typically a maximum of 2 to 2.5 inches of book spine can be perfect bound
7. Why cannot we do saddle stitching with common stapler?	Firstly, the length of a common stapler is 3 to 4 inches which can only stitch books of that page width. Secondly, the saddle stitch wire is specially designed to bind large number of pages, which a common stapler is not capable of.
8. What is the advantage of a spiral bind?	A spiral bind amongst other things, help turn the pages, it is the only binding type where the last page of a book can be folded flat on the first page of the book.
9. What is the difference between gathering and collating?	Forms of paper are gathered whereas individual pages are collated.
10. What is the difference between scoring and creasing?	Both are same.

Self-Assessment

(MCQs)

Please mark the correct one from the given options. You can check your answer with the Answer Key at the end of this module

1. What are the two types of grain?
 - a. New and Old
 - b. Right and Left
 - c. Normal and Large
 - d. Long and Short

2. How do you determine the paper grain?
Ans. _____

3. What is a dummy?
 - a. A meeting
 - b. A sample
 - c. A task
 - d. A project

4. Write any two types of binding.
Ans1. _____
Ans2. _____

5. Mixed paper is sourced by mixing pulp with plastic.
 - a. True
 - b. False

6. What does GSM stands for?
 - a. Gram per Square Meter
 - b. Grain per Substrate Measure
 - c. Getting Social Metric
 - d. Glue per Square Meter

7. In what shape does a GSM cutter cut?
 - a. Square
 - b. Triangle
 - c. Round
 - d. Pentagon

8. Case-bound books lay flat on the table.
 - a. True
 - b. False

9. VII is roman for:

- a. 4
- b. 7
- c. 9
- d. 11

10. How many creases does a perfect bound book has?

- a. 6
- b. 2
- c. 4
- d. 8

Answer Key

MCQ No.	Correct Answer
1	D
2	Tear test / Fingernail Test / Bend Test
3	B
4	Perfect, saddle stitch, hard bound, spiral
5	B
6	A
7	C
8	A
9	B
10	C

POST PRESS OPERATIONS (Publishing)

Learner Guide

National Vocational
Certificate Level 5

Version 1 - December 2019

Module-2

Module 2: - Develop Entrepreneur skills

Learning Unit:

After completion of this module the learner will be able to:

LU1: Develop a business plan

LU2: Collect information regarding funding sources

LU3: Develop a marketing plan

LU4: Motivate Team

Learning Unit - 1:

Institute/Develop a business plan

Overview: The purpose of this learning unit is to inform the learner to develop business plan.

Explain the 7Ps of marketing:

The 7Ps of marketing is one of these frameworks that you can use from your marketing toolkit. In 1960, Edmund Jerome McCarthy came up with the concept of the 4Ps marketing mix. The structure contained: product, price, place, and promotion. This framework was an adequate framework for the time which focused on products. As the economy developed and more service-based organizations started to rise. The 4Ps of the marketing mix got an update from Booms and Bitner in 1981. The 7Ps of service marketing is what came out from the update and what we will review today.

The 7Ps of the service marketing mix:

- Product
- Price
- Place
- Promotion
- People
- Processes
- Physical evidence

Describe 7Cs of business communication:

Seven Cs of communication provide a checklist for making sure that your meeting, emails, conference calls, reports, and presentations are well constructed and clear – so your audience gets your message.

According to the seven Cs, communication needs to be: clear, concise, concrete, correct, coherent, complete and courteous.

1. Clear

When writing or speaking to someone, be clear about your goal or message. What is your purpose in communicating with this person? If you're not sure, then your audience won't be sure either.

2. Concise

When you're concise in your communication, you stick to the point and keep it brief. Your audience doesn't want to read six sentences when you could communicate your message in three.

3. Concrete

When your message is concrete, then your audience has a clear picture of what you're telling them. There are details (but not too many!) and vivid facts, and there's laser-like focus. Your message is solid.

4. Correct

When your communication is correct, it fits your audience. And correct communication is also error-free communication.

5. Coherent

When your communication is coherent, it's logical. All points are connected and relevant to the main topic, and the tone and flow of the text is consistent.

6. Complete

In a complete message, the audience has everything they need to be informed and, if applicable, take action.

7. Courteous

Courteous communication is friendly, open, and honest. There are no hidden insults or passive-aggressive tones. You keep your reader's viewpoint in mind, and you're empathetic to their needs.

Define different modes of communication

Mode is a term used to describe the way something is done or experienced. When we use the phrase mode of communication, we are describing the way communication is expressed. In other words, we are discussing the method of communication. There are three modes of communication:

Interpersonal communication: Two-way communication with active negotiation of meaning among individuals

Interpretive communication: One-way communication with no recourse to the active negotiation of meaning with the writer, speaker, or producer

Presentational communication: One-way communication intended for an audience of readers, listeners, or viewers

Specific business terms used in the industry

In order for a business person to be successful, they have to learn a new set of vocabulary. Certain terms are applicable to all businesses, no matter the size. A list of 27 basic business terms

1. **Accounting** – a system that provides quantitative information about finances.
2. **Assets** – the value of everything a company owns and uses to conduct their business.
3. **Business** – an organization that operates with the intention of making a profit.
4. **Business to Business (B2B)** – one business sells goods or services to another business.
5. **Business to Consumer (B2C)** – a business sells goods or services directly to the end user.
6. **Contract** – a formal agreement to do work for pay.
7. **Depreciation** – the degrading value of an asset over time.
8. **Entrepreneur** – someone who organizes, manages and takes on the risk of starting a new business.
9. **Expense** – money spent on supplies, equipment or other investments.
10. **Finance** – the management and allocation of money and other assets.
11. **Fixed Cost** – a one-time expense that doesn't vary with business volume.
12. **Industry** – a category of like businesses.
13. **Liabilities** – the value of what a business owes to someone else.
14. **Management** – the act of organizing and conducting a business to accomplish goals and objectives.
15. **Marketing** – the process of promoting, selling and distributing a product or service.
16. **Net Income/Profit** – revenues minus expenses.
17. **Net Worth** – the total value of a business.
18. **Payback Period** – the amount of time it takes to recover the initial investment of a business.
19. **Product** – something produced or manufactured to be sold; a good.
20. **Profit Margin** – the ratio of profit divided by revenue displayed as a percentage.
21. **Return on Investment (ROI)** – how much money a business gets in return from an investment.
22. **Revenue** – the entire amount of income before expenses are subtracted.
23. **Sales Prospect** – a potential customer.
24. **Service** – work done for pay that benefits another.
25. **Supplier** – an organization that provides supplies to a business.
26. **Target Market** – a specific group of customers at which a company aims its products and services.
27. **Variable Cost** – expenses that change in proportion to the activity of a business.

Introduction of basic accounting

Accounting is a system meant for measuring business activities, processing of information into reports and making the findings available to decision-makers. The documents, which communicate these findings about the performance of an organization in monetary terms, are called financial statements.

Income statement

An income statement is one of the three important financial statements used for reporting a company's financial performance over a specific accounting period, with the other two key statements being the balance sheet and the statement of cash flows.

Balance sheet

The accounting balance sheet is one of the major financial statements used by accountants and business owners. The balance sheet is also referred to as the statement of financial position.

Profit margin calculation

In accounting and finance, a profit margin is a measure of a company's earnings (or profits) relative to its revenue. The three main profit margin metrics are gross profit margin (total revenue minus cost of goods sold (COGS)), operating profit margin (revenue minus COGS and operating expenses), and net profit margin (revenue minus all expenses, including interest and taxes). This guide will cover formulas and examples, and even provide an Excel template you can use to calculate the numbers on your own.

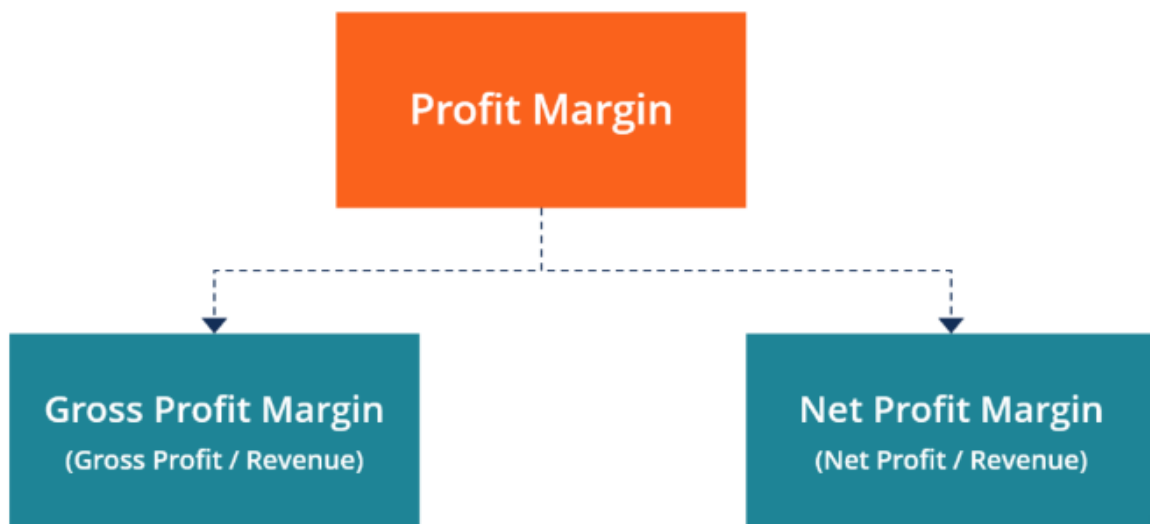

Profit margin formula

When assessing the profitability of a company, there are three primary margin ratios to consider: gross, operating, and net. Below is a breakdown of each profit margin formula.

Gross Profit Margin = $\text{Gross Profit} / \text{Revenue} \times 100$





Operating Profit Margin = $\text{Operating Profit} / \text{Revenue} \times 100$



Net Profit Margin = $\text{Net Income} / \text{Revenue} \times 100$

Practical Activity # 1

Develop a business plan

Develop Entrepreneur Skills		
Module: 2	Learning Unit: 1	Institute/Develop a business plan
	Practical Description:	Make a business for one product or service
Time:	14 Hours	
Equipment	n/a	
Tools	n/a	
PPE	n/a	
Materials	n/a	
Key Point	Information being gathered must be reliable and relevant to the market	
Learning Outcome:	<ul style="list-style-type: none"> • Conduct a market survey to collect following information <ul style="list-style-type: none"> ○ Customer /demand ○ Tools, equipment, machinery and furniture with rates ○ Raw material ○ Supplier ○ Credit / funding sources ○ Marketing strategy ○ Market trends ○ Overall expenses ○ Profit margin • Select the best option in terms of cost, service, quality, sales, profit margin, overall expenses • Compile the information collected through the market survey, in the business plan format 	
Precautions:	Carefully assess the collected information	
Instructions		Illustrations

<p>1. Use your personal network and the internet to find out what is the demand and pricing of your product or service</p>	
<p>2. Search for tools and equipment needed to make the product</p>	
<p>3. Search for raw materials required</p>	
<p>4. Search for raw material suppliers</p>	
<p>5. Search for funding sources</p>	

6. Search for labor availability	
7. Analyze the collected information	
8. Make a financial feasibility based on findings	N/A 
9. Make a marketing plan based on your findings	

Learning Unit - 2:

Collect information regarding funding sources

Overview: The purpose of this learning unit is to inform the learner to collect information regarding funding sources.

Enlist the available funding sources

Business simply cannot function without money, and the money required to make a business function is known as business funds. Throughout the life of business, money is required continuously. Sources of funds are used in activities of the business. They are classified based on time period, ownership and control, and their source of generation.

Period Basis Sources

On the basis of the period, the different sources of funds can be classified into three parts. Which are:

Long-term sources fulfil the financial requirements of a business for a period more than 5 years. It includes various other sources such as shares and debentures, long-term borrowings and loans from financial institutions. Such financing is generally required for the procurement of fixed assets such as plant, equipment, machinery etc.

Medium-term sources are the sources where the funds are required for a period of more than one year but less than five years. The sources of the medium term include borrowings from commercial banks, public deposits, lease financing and loans from financial institutions.

Short-term sources: Funds which are required for a period not exceeding one year are called short-term sources. Trade credit, loans from commercial banks and commercial papers are the examples of the sources that provide funds for short duration.

How to Get a Loan to Start a Business:

Getting a loan to start a business is easier said than done. There's no question—getting a business up and running is easier when you have a little money to work with. But where can you go to get the funds you need to get your startup off the ground when small business loans can be hard to come by as a startup? Well, there are the tried-and-true financing options for funding your new business: family and friends, private investors, crowd funding, and more.

But these days, small business owners have another option: startup business loans. Unlike crowd funding or investors, startup loans are traditional sources of small business funding. Startup loans allow business owners to work with traditional lenders, just as they would with other business loans.

Here are the five steps of how to get a loan to start a business:

Review your startup costs. Be sure to understand what you're using the loan for by reviewing the startup costs you face.

Get your documents and registrations together. Take care of the basics like your business plan, your credit score, the necessary documentation, and the necessary registrations.

Check your qualifications. Up your chances to qualify by improving your credit, building your assets, expanding your customer base, and updating your financial projections.





Choose the right startup loan. Choose which type of startup loans you want to go for—equipment financing, business lines of credit, business credit cards, or credit line builders.

Apply. Last, simply apply! If you do get an offer, be sure to read the fine print before you accept.

Practical Activity # 2

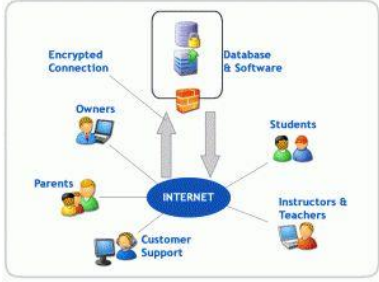
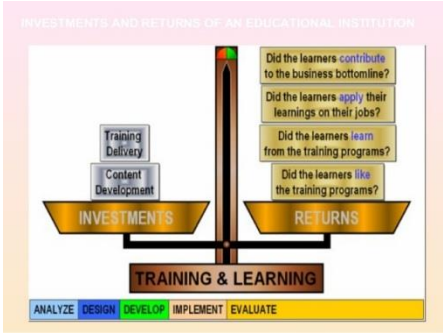
Search for funding sources available

Develop Entrepreneur Skills		
Module: 2	Learning Unit: 2	Collect information regarding funding sources
	Practical Description:	Make a business for one product or service
Time:	4 Hours	
Equipment	n/a	
Tools	n/a	
PPE	n/a	
Materials	n/a	
Key Point	Information being gathered must be reliable and relevant to the market	
Learning Outcome:	<ul style="list-style-type: none"> • Identify the available funding sources based on their terms and conditions, maximum loan limit, payback time, interest rate • Choose the best available option according to investment requirement • Prepare documents according to the loan agreement requirement • Include the information of funding sources in the business plan 	
Precautions:	Carefully assess the collected information	
Instructions		Illustrations

<p>1. Use your personal network and the internet to find out which banks offer business financing</p>	
<p>2. Search for incubator centers / venture capitalists / investors looking for investment opportunities</p>	
<p>3. When located a good funding source, find out the prerequisite documents</p>	
<p>4. Complete your funding application with the prerequisite documents and make an official request</p>	
<p>5. Include the funding information in your business plan</p>	

Learning Unit - 3:

Develop a marketing plan

Overview: The purpose of this learning unit is to inform the learner to Develop a marketing plan.

Market survey and its tools

Market survey is the survey research and analysis of the market for a particular product/service which includes the investigation into customer inclinations. A study of various customer capabilities such as investment attributes and buying potential. Market surveys are tools to directly collect feedback from the target audience to understand their characteristics, expectations, and requirements.

Purpose of Market Survey

Gain critical customer feedback: The main purpose of the market survey is to offer marketing and business managers a platform to obtain critical information about their consumers so that existing customers can be retained and new ones can be got onboard.

Understand customer inclination towards purchasing products: Details such as whether the customers will spend a certain amount of money for their products/services, inclination levels among customers about upcoming features or products, what are their thoughts about the competitor products etc.

Enhance existing products and services: A market survey can also be implemented with the purpose of improving existing products, analyze customer satisfaction levels along with getting data about their perception of the market and build a buyer persona using information from existing clientele database.

Make well-informed business decisions: Data gathered using market surveys is instrumental in making major changes in the business which reduces the degree of risks involved in taking important business decisions.

Market trends for specific product offering

In order to conduct various types of market surveys, successful enterprises in today's world, use powerful market research survey software to get actionable market insights through real-time data collection and robust analytics. Following are the top 10 types of market surveys that are conducted by successful enterprises.

1. Market Surveys for segmentation: An organization can spot existing and prospective customers and understand why the customers have chosen their products/services and the prospects have not yet made a purchase. This can lead to a structured market segmentation and analysis.

2. Market Surveys for exploring various aspects of the target market: Get information about factors such as market size, demographic information such as age,

gender, family income etc. to lay out a roadmap by considering growth rate of the market, positioning, and average market share.

3. Market Surveys to probe into purchase procedure: How does a customer deciding on making a purchase? What are the factors that convert product awareness into sales? This type of market survey will unveil awareness, information, free trial, purchase, and repeat.

4. Market Surveys to establish buyer persona: These surveys are to build a buyer persona by knowing about customer preferences, inclination, and capabilities of purchasing a product.

5. Market Surveys to measure customer loyalty: What is the degree of loyalty that the customers have towards and organization? The answer to this question can be obtained by conducting a market survey.

6. Market Surveys to analyze a new feature or concept: It is essential for an organization to include market-compliant features and concepts. By carrying out a market survey to understand which features to launch, will help all the teams involved in the feature development process to do that with proper research.

7. Market Surveys for competitor analysis: Healthy competition is always good for an organization's progress. Market surveys done with the motive of competitor analysis will produce results about how does the target market weigh the organization's products/services in comparison to the others in the market.

8. Market Surveys to understand the impact of sales activities: Sales activities are the backbone of an organization and it becomes crucial to keep track of these activities. Market surveys for sales activities will produce a report of the impact of sales activities, whether their frequency needs to increase or any changes the audiences think should be inculcated in the sales process.



9. Market Surveys to assess prices for new products/services: Affordability of products also is an aspect that drives the market for organizations. Price ranges, product variants to cater multiple price ranges, target customers for each of the products etc.

10. Market Surveys for evaluation of customer service: Good customer service can lead to enhanced satisfaction levels among customers. Factors such as time taken to resolve issues, the scope of improvement, best practices of customer service etc.

Practical Activity # 3

Develop marketing plan

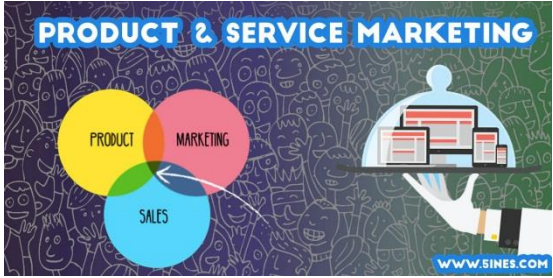
		Develop Entrepreneur Skills	
Module: 2	Learning Unit: 3	Develop a marketing plan	
	Practical Description:	Make a marketing plan for one product or service	
Time:	6 Hours		
Equipment	n/a		
Tools	n/a		
PPE	n/a		
Materials	n/a		
Key Point	Information being gathered must be reliable and relevant to the market		
Learning Outcome:	<ul style="list-style-type: none"> • Make a marketing plan for the business including product, price, placement, promotion, people, packaging and positioning • Include the information of marketing plan in the business plan 		
Precautions:	Carefully assess the collected information		
Instructions		Illustrations	
<ol style="list-style-type: none"> 1. Collect market information through interviews and surveys 			

<p>2. Select the best product or service to market based on market information</p>	
<p>3. Settle on a price to be offered to customers based on market information</p>	
<p>4. Select the geographical market where you can offer your product or service</p>	
<p>5. Select communication tools you can use to promote your product or service</p>	

Learning Unit - 4:

Motivate Team

Overview: The purpose of this learning unit is to inform the learner to Motivate Team.

Motivation theory

This theory suggests that there are actually two motivation systems: intrinsic and extrinsic that correspond to two kinds of motivators: intrinsic motivators: Achievement, responsibility and competence. Motivators that come from the actual performance of the task or job -- the intrinsic interest of the work.

Ground rules for team work.

Ground rules are statements of values and guidelines which a group establishes consciously to help individual members to decide how to act. To be effective, ground rules must be clear, consistent, agreed-to, and followed. Where articulated ground rules are missing, natural behavior patterns often emerge spontaneously. These are referred to as norms.

Team ground rules define a behavioral model which addresses how individuals treat each other, communicate, participate, cooperate, support each other, and coordinate joint activity. They may be used to define and standardize team procedure, use of time, work assignments, meeting logistics, preparation, minutes, discussion, creativity, reporting, and respect.

A team should create and adopt written ground rules during the first few organizing sessions. The rules should be consulted and enforced through reminders and team process checks. They should be added to and revised as needed.

Example of Team Ground rules

- Our attitude and culture
- Team meetings
- Communication and Decision-Making

Importance of motivation

Employee motivation is a critical aspect at the workplace which leads to the performance of the department and even the company. Motivating your employees needs to be a regular routine.

Motivation is incitement or inducement to act or move. It is the process of inducing the employees of an organization to act in a predetermined desired manner so as to achieve organizational goals. At the core of this concept, lies three important sub-concepts. They are Motive, Motivation, and Motivator.

Motive refers to the inner state of mind that initiates and controls behavior towards business goals. They directly correspond to the needs of individuals. Motivation is the process of stimulating action by understanding the needs of employee and by utilizing their motives. Motivator is the technique used for motivation such as pay bonus, promotion among others.

The following aspects may be considered under this head:

- Increases Productivity
- Ensures Organizational Efficiency
- Ensures Loyal Workforce
- Ensures a Reactive Workforce
- Facilitates Direction

Role of leadership

Leadership is the action of leading people in an organization towards achieving goals. Leaders do this by influencing employee behaviors in several ways. A leader sets a clear vision for the organization, motivates employees, guides employees through the work process and builds morale.

3 important role of leadership

1. To define of visions
2. To show the way, how to achieve visions
3. To know and to do right things





Leadership impacts across nine dimensions

- Challenge/Involvement
- Freedom
- Trust/Openness
- Idea time
- Playfulness
- Conflict reduction
- Idea support
- Debate risk taking

Practical Activity # 4

Role-play team development meeting

Develop Entrepreneur Skills		
Module: 2	Learning Unit: 4	Motivate Team
	Practical Description:	Perform a role-play team development meeting for employee motivation
Time:	6 Hours	
Equipment	n/a	
Tools	n/a	
PPE	n/a	
Materials	n/a	
Key Point	Plan how your organization will treat your employees and team members	
Learning Outcome:	<ul style="list-style-type: none"> • Develop positive and constructive relationships with and between team members • Facilitate team communication processes • Involve team members in the following processes, to ensure acceptance and support. <ul style="list-style-type: none"> ○ Examining risks and options ○ Making decisions • Promote coordinated efforts • Determine strengths and weaknesses of team members • Recognize team members' queries and deal with it. 	
Precautions:	Carefully assess the organization culture for HR development	
Instructions		Illustrations

<p>1. Greet all participants and narrate the agenda</p>	
<p>2. Ask for the problems the employees face in daily operations</p>	
<p>3. Ask for viable solutions for each problem</p>	
<p>4. Communicate future organizational HR development plans e.g; trainings and workshops</p>	
<p>5. Ask for feedback on the organizational plan</p>	

Summary of the Module

In the Module of entrepreneur skills the following points have been covered

- Develop a business plan
- Collect information regarding funding sources
- Develop a marketing plan
- Motivate Team

In the above mentioned topics some critical areas also briefed like

7Ps of marketing

The 7Ps of the service marketing mix:

- Product
- Price
- Place
- Promotion
- People
- Processes
- Physical evidence

7Cs of communications

- 1. Clear
- 2. Concise
- 3. Concrete
- 4. Correct
- 5. Coherent
- 6. Complete
- 7. Courteous

Frequently Asked Questions (FAQs)

Question	Answer
1. Why does a post-press supervisor need to learn marketing?	A post press supervisor can be an entrepreneur trying to run or start his own post press facility for which he will have to supervise marketing as well.
2. Why is business communication difficult?	It is not difficult. It is detailed. Many businesses over the years have found these communication techniques to be effective in business environment.
3. What is the difference between a businessman and an entrepreneur?	A businessman makes his place in the market with his efforts and dedication, whereas an entrepreneur creates the market for his own business.
4. Why is electricity variable cost?	As it incurs with every unit used, it is variable according to usage, hence it is called a variable cost.
5. What is the best source of funding?	Depending on the requirement, different sources of funding for a business are designed for each type of business need.
6. Isn't it risky to start a business with a loan?	If the planning is done well and executed well, a calculated risk can yield great returns to the investors as well as entrepreneurs.
7. Do customers share information for a marketing survey?	If you let them know how you will use the information, they should not have any problem with sharing information with you.
8. Should we follow market trends?	The best way to use market trends is to analyze them and predict the next trend.

Self-Assessment

(MCQs)

Please mark the correct one from the given options. You can check your answer with the Answer Key at the end of this module

1. List two P's of marketing?

Ans1. _____

Ans2. _____

2. List two C's of communication?

Ans1. _____

Ans2. _____

3. What is interpersonal communication?

- a. Online communication
- b. Personal communication
- c. At home communication
- d. Two-way communication

4. What does ROI stands for?

- a. Return on Investment
- b. Return of Industry
- c. Rule of Inside
- d. Route of Investment

5. What is a balance sheet?

- a. A mechanical tool
- b. A quality test
- c. A financial statement
- d. A unit of measure

6. Why does a business need money?

- a. To make plans
- b. To fund business activities
- c. To make statements
- d. To put in banks

7. The purpose of a market survey is to understand the customer needs.

- a. True
- b. False

8. Which Market surveys done with the motive of finding how does the target market weigh the organization's products/services in comparison to the others in the market?
- a. Segmentation survey
 - b. Persona survey
 - c. Competitor analysis
 - d. Pricing analysis
9. Team ground rules are statement of values
- a. True
 - b. False
10. Who should define the company vision?
- a. Suppliers
 - b. Leaders
 - c. Investors
 - d. Customers

Answer Key

MCQ No.	Correct Answer
1	Product, Price, Place, Promotion, People, Processes, Physical evidence
2	Clear, concise, concrete, correct, coherent, complete and courteous.
3	D
4	A
5	C
6	B
7	A
8	C
9	A
10	B

POST PRESS OPERATIONS (Publishing)

Learner Guide

National Vocational
Certificate Level 5

Version 1 - December 2019

Module-3

Module 3: - Manage a team

Learning Unit:

After completion of this module the learner will be able to:

LU1: Facilitate team Development

LU2: Motivate Team Monitor

LU3: Team effectiveness

Learning Unit - 1:

Facilitate team Development

Overview: The purpose of this learning unit is to inform the learner to identify work requirements, assist team, allocate duties, identify roles / responsibilities and discuss performance to individual team member.

Explain management styles

Leaders are confronted with a number of different management situations throughout their careers, and how they choose to handle these varying circumstances depends on their management style.

There's no one-size-fits-all approach to management—it's all situational. But understanding the difference between the many different types of management styles, and how certain employees respond to them, will make you a more effective leader.

Democratic management style

As its name suggests, a democratic management style invites employees to get involved in making decisions. Democratic management involves extensive communication from both managers and employees. This management style can be particularly useful when various specialized skills are needed to complete a project. Because everyone is given the chance to participate and exchange ideas, people can showcase their specialties and add to the outcome of the project from ideation through to completion. Democratic management can only be successful when decision-making processes are streamlined and managed properly.

Persuasive management style

Persuasive managers control all decision-making, but they spend more time with employees than a purely autocratic leader. Instead of working behind a closed office door, for example, a persuasive manager is in the meetings and in the workshop doing the work alongside his employees (even if he is calling the shots). This on-the-level approach allows managers to lead by example, and helps employees understand the benefits of their manager's decisions. Persuasive managers are not necessarily more inclusive of their employees when it comes to decision-making, but they tend to be more aware of the work they are doing.

Laissez-faire management style

A laissez-faire manager is seen as more of a mentor than a manager. With laissez-faire management, employees are empowered to take charge and managers take a backseat role so that employees can flourish creatively.

Describe methods of monitoring performance

- Operations analysis of orders, order status, work in process and completion times

- Labor, materials and overhead variance analysis
- Manufacturing Scorecard of key metrics like these:
 - Production quality
 - Performance to schedule
 - Labor productivity
 - Machine productivity
 - Labor efficiency
 - Effective output
 - Labor utilization
 - Machine utilization
 - Machine efficiency
 - Machine output
 - Waste analysis

Outline the relevant legal requirements

Different types of companies registered in Pakistan (Classification based by virtue of legal form):

Statutory Company

The company that is formed under special statute is called statutory company. This type of company is governed by the ordinance under which this type of company is created. As in most of other parts of the world there are companies in Pakistan that are formed under some special statute. In Pakistan one of the most renowned statutory companies is State Bank of Pakistan. State Bank of Pakistan is a statutory company and is regulated by the state bank of Pakistan ordinance.

Chartered company

Chartered company is formed under a special charter granted by the head of the state, or Queen or King in some countries. This type of company normally enjoys some special rights or privileges over other companies. The Chartered Bank of England is an example of chartered company.

Government Company

Government company is the type of company in which majority of the shareholding is controlled by the Government or in other words if 51% or more of the paid up capital of the company is owned by the Government such type of company is called Government company. Further a company which is a subsidiary of the Government Company is also called Government Company.

Registered Company

A registered company in Pakistan is the company which is registered under the provisions of the Companies Ordinance, 1984. These companies have different types which are explained below:

Company Limited by Shares

A company limited by shares is the type of company in which the liability of the members of the company is limited to the amount unpaid on the shares if any. In simple words if company has authorized capital of Rs. 100,000 out of which members have paid just Rs. 40,000 then in case of any legal action or other dispute the members of the company are liable to contribute just Rs. 60,000.

Company Limited by guarantee

A company limited by guarantee is the type of company in which the liability of the members of the company is limited up to the amount undertaken by members to contribute in the event of winding up of the company. In simple words the liability of the members is limited up to the amount guarantee by them.

Unlimited company

Unlimited company is the type of company in which the liability of the members of the company is unlimited. In simple words if the company is in the course of winding up then to settle creditors and other claims against the company there is no limit of contribution and even the personal assets of the members can be ordered to be taken in custody for the purpose of settlements of winding up of the company.

Following Procedure is to be followed for incorporation of a new company under the Companies Act, 2017:-

a. Availability of Name

The first step with regard to incorporation of a company is to seek the availability of the proposed name for the company from the concerned registrar of companies designated by SECP. For this purpose, an application is to be made and Rs.200/- for online application and Rs.500/- for offline application is required to be paid seeking availability certificate for each name. To facilitate the promoters, a list of prohibited/sensitive names has also been provided at the link: <https://www.secp.gov.pk/prohibitedwords/>.

- #### b. Submission of Documents for incorporation of a Private Limited Company. After getting the name availability certificate, following documents are required to be filed with the registrar concerned for incorporation of a private limited company:-
- I. Copy of national identity card/NICOP or passport, in case of foreigner, of each subscriber and witness to the memorandum and articles of association,
 - II. Copy of CNIC/NCOP of Nominee only in case of Single member company or copy of passport in case of foreigner.

NTN REGISTRATION PROCESS

- **ONLINE REGISTRATION**

Online registration is available only for:

Individual and not for Association of Person or Company. Before starting online registration, the Taxpayer must have:

- Read User Guide;
- A computer, scanner and internet connection;
- A cell phone with SIM registered against their own CNIC;
- A personal email address belonging to them;
- Scanned pdf files of:
 - Certificate of maintenance of personal bank account in his own name;
 - Evidence of tenancy / ownership of business premises, if having a business;
 - Paid utility bill of business premises not older than 3 months, if having a business.
 - Online registration is available at Iris

REGISTRATION AT FACILITATION COUNTERS OF TAX HOUSES

Registration at Facilitation Counters of Tax Houses is available for all:

Individual, Association of Person and Company;

Income Tax and Sales Tax;

For registration of an individual, the individual must:

- Personally go to any Facilitation Counter of any Tax House;
- Take the following documents with him:
 - Original CNIC;
 - Cell phone with SIM registered against his own CNIC;
 - Personal Email address belonging to him;
 - Original certificate of maintenance of personal bank account in his own name;
 - Original evidence of tenancy / ownership of business premises, if having a business;
 - Original paid utility bill of business premises not older than 3 months, if having a business.





After incorporation with relevant tax authorities and registrars, the company needs the following registrations to operate legally in Pakistan:

- EOBI (Employee Old-Age Benefit Institution)
- ESSI (Employee Social Security Institution) [Provincial]
- Labor department (Shop Act)
- Labor department (Health and Safety)
- Press declaration from District Commissioner
- Professional tax registration
- Trade registration with town government
- Municipal Commission (if sign board is installed)

Practical Activity # 1

Role-play roles and responsibilities distribution meeting

		Manage a team	
Module: 3	Learning Unit: 1	Facilitate team Development	
	Practical Description:	Make a scenario based plan for distribution of roles and responsibilities in the workplace	
Time:	10 Hours		
Equipment	n/a		
Tools	n/a		
PPE	n/a		
Materials	n/a		
Key Point	Identify key roles properly		
Learning Outcome:	<ul style="list-style-type: none"> • Identify work requirements, standards and purpose of team members. • Assist team to develop <ul style="list-style-type: none"> ○ Objectives ○ Targets ○ Key performance indicators • Allocate duties as per individual skills • Identify roles, responsibilities and expectations of each team member • Discuss performance expectations to individual team members. 		
Precautions:	Operators must be consulted before assigning responsibilities		
Instructions		Illustrations	
1. Identify project requirements and processes needed			

<p>2. Make a list of employees that will work on the project</p>	
<p>3. Make a tentative distribution of roles and responsibilities</p>	
<p>4. Appoint key personnel for overall safety and monitoring of the project</p>	
<p>5. Discuss roles and responsibilities with each personnel to get their feedback</p>	
<p>6. Decide key deliverables and key performance indicators for each role</p>	
<p>7. Finalize plan and share with all team members to avoid confusion during operation</p>	

Learning Unit - 2:

Motivate Team

Overview: The purpose of this learning unit is to inform the learner to develop positive relationships with and between team members.

Describe communication skills

Communication skills are abilities you use when giving and receiving different kinds of information. Communication skills involve listening, speaking, observing and empathizing. It is also helpful to understand the differences in how to communicate through face-to-face interactions, phone conversations and digital communications, like email and social media.

There are different types of communication skills you can learn and practice to help you become an effective communicator:

Active listening

Active listening means paying close attention to the person who is speaking to you. People who are active listeners are well-regarded by their coworkers because of the attention and respect they offer others. While it seems simple, this is a skill that can be hard to develop and improve.

Adapting your communication style to your audience

Different styles of communication are appropriate in different situations. To make the best use of your communication skills, it's important to consider your audience and the most effective format to communicate with them in.

Friendliness

In friendships, characteristics such as honesty and kindness often foster trust and understanding. The same characteristics are important in workplace relationships. When you're working with others, approach your interactions with a positive attitude, keep an open mind and ask questions to help you understand where they're coming from.

Confidence

In the workplace, people are more likely to respond to ideas that are presented with confidence. There are many ways to appear confident, including by making eye contact when you're addressing someone, sitting up straight with your shoulders open and preparing ahead of time so your thoughts are polished. You'll find confident communication comes in handy not just on the job but during the job interview process as well.

Giving and receiving feedback

Strong communicators are able to accept critical feedback and provide constructive input to others. Feedback should answer questions, provide solutions or help strengthen the project or topic at hand.

Volume and clarity

When you're speaking, it's important to be clear and audible. Adjusting your speaking voice so you can be heard in a variety of settings is a skill, and it's critical to communicating effectively. Speaking too loudly may be disrespectful or awkward in certain settings. If you're unsure, read the room to see how others are communicating.

Empathy

Having empathy means that you can understand and share the emotions of others. This communication skill is important in both team and one-on-one settings. In both cases, you will need to understand other people's emotions and select an appropriate response. For example, if someone is expressing anger or frustration, empathy can help you acknowledge and diffuse their emotion. At the same time, being able to understand when someone is feeling positive and enthusiastic can help you get support for your ideas and projects.

Respect

A key aspect of respect is knowing when to initiate communication and respond. In a team or group setting, allowing others to speak without interruption is seen as a necessary communication skill tied to respectfulness. Respectfully communicating also means using your time with someone else wisely — staying on topic, asking clear questions and responding fully to any questions you've been asked.





Understanding nonverbal cues



A great deal of communication happens through nonverbal cues such as body language, facial expressions and eye contact. When you're listening to someone, you should be paying attention to what they're saying as well as their nonverbal language. By the same measure, you should be conscious of your own body language when you're communicating to ensure you're sending appropriate cues to others.

Practical Activity # 2

Role-play employee meeting before starting a project

		Manage a team	
Module: 3	Learning Unit: 2	Motivate Team	
	Practical Description:	Make a scenario based meeting where employees are being handed over a new project	
Time:	10 Hours		
Equipment	n/a		
Tools	n/a		
PPE	n/a		
Materials	n/a		
Key Point	Identify key roles properly		
Learning Outcome:	<ul style="list-style-type: none"> • Develop positive and constructive relationships with and between team members • Facilitate team communication processes • Involve team members in the following processes, to ensure acceptance and support. <ul style="list-style-type: none"> ○ examining risks and options ○ making decisions • Promote coordinated efforts • Determine strengths and weaknesses of team members • Recognize team members' queries and deal with it. 		
Precautions:	Operators must be consulted before assigning responsibilities		
Instructions		Illustrations	

<p>1. Develop positive and constructive relationships with and between team</p>	
<p>2. Facilitate team communication processes</p>	
<p>3. Involve team members in examining risks and options</p>	
<p>4. Involve team members in making decisions</p>	
<p>5. Promote coordinated efforts</p>	

<p>6. Determine strengths and weaknesses of team members</p>	 An illustration of a white balance scale on a purple background. The left pan is higher and contains a yellow box labeled 'Strengths'. The right pan is lower and contains a blue box labeled 'Weaknesses'. The scale is balanced.
<p>7. Recognize team members' queries and deal with it</p>	 An illustration of a man in a blue shirt standing in front of a whiteboard, presenting a flowchart. Three people are seated in front of him, looking at the board. One person has their hand raised. The flowchart on the whiteboard has several boxes connected by lines, with a green checkmark and a red 'X' in some boxes.

Learning Unit - 3:

Monitor team effectiveness

Overview: The purpose of this learning unit is to inform the learner to monitor work plan and performance of team.

Outline strategies for dealing effectively with team member complaints or grievances

Learn about some practical strategies you can use to handle grievances in the workplace.

1. Talk with the other person.
2. Focus on behavior and events, not on personalities.
3. Listen carefully.
4. Identify points of agreement and disagreement.
5. Prioritize the areas of conflict.
6. Develop a plan to work on each conflict.
7. Follow through on your plan.
8. Build on your success.

Explain team dynamics and facilitation processes

People often take on distinct roles and behaviors when they work in a group. "Group dynamics" describes the effects of these roles and behaviors on other group members, and on the group as a whole.

A group with a positive dynamic is easy to spot. Team members trust one another, they work towards a collective decision, and they hold one another accountable for making things happen. As well as when a team has a positive dynamic, its members are nearly twice as creative as an average group.

In a group with poor group dynamics, people's behavior disrupts work. As a result, the group may not come to any decision, or it may make the wrong choice, because group members could not explore options effectively.

Group leaders and team members can contribute to the group dynamic. Let's look at some of the most common problems that can occur:

Weak leadership: when a team lacks a strong leader, a more dominant member of the group can often take charge. This can lead to a lack of direction, infighting, or a focus on the wrong priorities.

Excessive deference to authority: this can happen when people want to be seen to agree with a leader, and therefore hold back from expressing their own opinions.

Blocking: this happens when team members behave in a way that disrupts the flow of information in the group.

Groupthink: this happens when people place a desire for consensus above their desire to reach the right decision. This prevents people from fully exploring alternative solutions

Group dynamics can be improved by:

Knowing Your Team Well

As a leader, you need to guide the development of your group. So, start by learning about the phases that a group goes through as it develops. When you understand these, you'll be able to preempt problems that could arise, including issues with poor group dynamics.

Tackle Problems Quickly

If you notice that one member of your team has adopted a behavior that's affecting the group unhelpfully, act quickly to challenge it.

Define Roles and Responsibilities

Teams that lack focus or direction can quickly develop poor dynamics, as people struggle to understand their role in the group.

Break Down Barriers

Use team-building exercises to help everyone get to know one another, particularly when new members join the group. These exercises ease new colleagues into the group gently, and also help to combat the "black sheep effect," which happens when group members turn against people they consider different.

Focus on Communication

Open communication is central to good team dynamics, so make sure that everyone is communicating clearly and avoid any ambiguity and ensure that everyone has the same information.







Pay Attention

Watch out for the warning signs of poor group dynamics. Pay particular attention to frequent unanimous decisions, as these can be a sign of groupthink, bullying, or free riding. If there are frequent unanimous decisions in your group, consider exploring new ways to encourage people to discuss their views, or to share them anonymously.

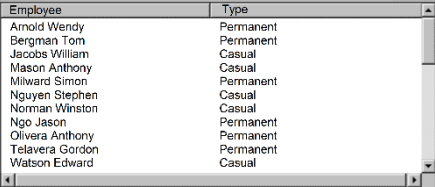
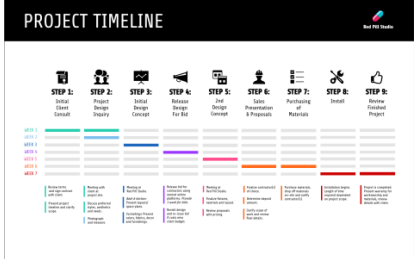
Practical Activity # 3

Role-play employee meeting before starting a project

		Manage a team	
Module: 3	Learning Unit: 3	Monitor team effectiveness	
	Practical Description:	Make a scenario based meeting where employees are being evaluated on performance criterion	
Time:	10 Hours		
Equipment	n/a		
Tools	n/a		
PPE	n/a		
Materials	n/a		
Key Point	Workplace policies should be coherent with employee temperament and working procedures		
Learning Outcome:	<ul style="list-style-type: none"> • Monitor the implementation of work plan according to workplace policies and procedures. • Monitor performance against defined performance criteria • Support team in identifying and resolving problems • Consult team members in any review and revision of team objectives and goals. • Address performance issues which cannot be rectified within the team to appropriate personnel according to employer policy. • Address concerns of team members • Keep team members informed about <ul style="list-style-type: none"> ○ Changes in prioritized assignments ○ Policies • Monitor team operations 		
Precautions:	Operators must be consulted for developing performance indicators		
Instructions		Illustrations	

<p>1. List down employees that worked on the project</p>	 <table border="1"> <thead> <tr> <th>Employee</th> <th>Type</th> </tr> </thead> <tbody> <tr><td>Arnold Wendy</td><td>Permanent</td></tr> <tr><td>Bergman Tom</td><td>Permanent</td></tr> <tr><td>Jacobs William</td><td>Casual</td></tr> <tr><td>Mason Anthony</td><td>Casual</td></tr> <tr><td>Milward Simon</td><td>Permanent</td></tr> <tr><td>Nguyen Stephen</td><td>Casual</td></tr> <tr><td>Norman Winston</td><td>Casual</td></tr> <tr><td>Ngo Jason</td><td>Permanent</td></tr> <tr><td>Olivera Anthony</td><td>Permanent</td></tr> <tr><td>Talavera Gordon</td><td>Permanent</td></tr> <tr><td>Watson Edward</td><td>Casual</td></tr> </tbody> </table>	Employee	Type	Arnold Wendy	Permanent	Bergman Tom	Permanent	Jacobs William	Casual	Mason Anthony	Casual	Milward Simon	Permanent	Nguyen Stephen	Casual	Norman Winston	Casual	Ngo Jason	Permanent	Olivera Anthony	Permanent	Talavera Gordon	Permanent	Watson Edward	Casual
Employee	Type																								
Arnold Wendy	Permanent																								
Bergman Tom	Permanent																								
Jacobs William	Casual																								
Mason Anthony	Casual																								
Milward Simon	Permanent																								
Nguyen Stephen	Casual																								
Norman Winston	Casual																								
Ngo Jason	Permanent																								
Olivera Anthony	Permanent																								
Talavera Gordon	Permanent																								
Watson Edward	Casual																								
<p>2. List down project deliverables and timelines that were executed</p>																									
<p>3. Take feedback from workers whose deliverables were late</p>																									
<p>4. Take note of any safety violations and make policies so that they are not repeated</p>																									
<p>5. Take note of process bottlenecks and ensure that they are not repeated</p>																									
<p>6. Analyze employee performance against KPIs</p>																									
<p>7. Finalize analysis and ask employees for feedback</p>																									

Summary of the Module

In the Module of Manage a team the following topics have been covered

- Facilitate team Development
- Motivate Team Monitor
- Team effectiveness

In the above mentioned topics some critical areas also briefed like

Different Management styles

- Democratic management style
- Persuasive management style
- Laissez-faire management style

Performance monitoring methods

Knowledge of legal requirements

- Statutory Company
- Chartered company
- Government Company
- Registered Company
- Company Limited by guarantee
- Company Limited by Shares
- Unlimited company

NTN registration process

- Online registration
- Registration at facilitation counters of tax houses

Frequently Asked Questions (FAQs)

Question	Answer
1. Why does the leader take the back-seat in laissez-faire management?	It is a type of management style where a leader chooses to empower his team members by de centralizing decision making.
2. What is variance analysis?	The difference between two values is called a variance; it can be the same value calculated at different times like the price of a consumable or different values calculated together like the values of two consumables at a time.
3. What is the companies' ordinance 1984?	All organizations in a country are governed by a set of rules which highlight their respective rights and responsibilities. Commercial organizations are governed by Companies Ordinance 1984.
4. What is a tax house?	FBR has placed various facilitation centers for taxpayers throughout the country, they are called tax houses.
5. When lithographic printing was invented?	The first lithographic (printing with stone) printing was invented by Johannes Gutenberg in Germany
6. What is a KPI (Key Performance Indicator)?	A KPI is a factors based on which performance is calculated.
7. Why is listening important when you are a leader and you only have to give orders?	The role of the leader is not to give orders but to lead, and in order to do that the leader must listen to the team otherwise the vision-gap can cause a team collapse.
8. Is an effective team more profitable?	Being profitable has more factors attached to it but an effective team is efficient and therefore use less resources to produce better results and can lead to more profits.
9. Is it more important to pay attention to customers or tem members?	Both are very important; if customer needs are left unchecked that can lead to loss of revenue and if team members are left to be on their own completely, operations can fall apart.

Self-Assessment

(MCQs)

Please mark the correct one from the given options. You can check your answer with the Answer Key at the end of this module

1. Which of the following is a management style?
 - a. Collative
 - b. Persuasive
 - c. Financial
 - d. Verbal

2. Productivity is a measure of?
 - a. Performance
 - b. Leadership
 - c. Employee count
 - d. Tax

3. A startup is registered as a government company
 - a. True
 - b. False

4. Which authority has a list of prohibited words which cannot be the name of the company?
 - a. FBR
 - b. EOBI
 - c. Provincial government
 - d. SECP

5. NTN stands for?
 - a. National Total Number
 - b. Natural Tax Number
 - c. National Tax Number
 - d. National Tax Nation

6. Duty and roles are?
 - a. Same
 - b. Different
 - c. Calculated in statement
 - d. Types of communication

7. What type of communication is body language?
 - a. Healthy
 - b. Personal
 - c. Non-verbal
 - d. Verbal

8. Sharing information enhances relationship?
 - a. True
 - b. False

9. What describes the effects of these roles and behaviors on other group members?
 - a. Team meetings
 - b. Team leader
 - c. Team payment
 - d. Team dynamics

10. Project deliverables can be completed without completing the sub-deliverables
 - a. True
 - b. False

Answer Key

MCQ No.	Correct Answer
1	B
2	A
3	B
4	D
5	C
6	A
7	C
8	A
9	D
10	B

POST PRESS OPERATIONS (Publishing)

Learner Guide

National Vocational
Certificate Level 5

Version 1 - December 2019

Module-4

Module 4: - Plan business activities

Learning Unit:

After completion of this module the learner will be able to:

LU1: Plan work activities

LU2: Schedule work activities

LU3: Implement work activities

LU4: Monitor work activities

LU5: Review and evaluate work plans and activities.

Learning Unit - 1:

Plan work activities

Overview: The purpose of this learning unit is to inform the learner to plan work activities.

Organizing

Good business organization can keep your operations running smoothly. Follow these tips to know how to organize a business so your company runs like a well-oiled machine.



Planning

Business planning include the following steps:



Team work and consultation strategies

When looking to improve teamwork in your organization, use the following teamwork strategies to help take your team to the next level.

Lead by example

Treat your own roles, responsibilities and relationships with coworkers the same way you want others to.

Build up trust and respect

Team members must trust each other to each do their part as well as trust their leaders to be guiding them in the right direction.

Cultivate open communication

Communication is a two-way street and employees should feel like they can add to the conversation both with superiors and peers.

Clearly outline roles and responsibilities

This will help limit confusion or time spent organizing and delegating work so individuals can simply focus on their task at hand.

Organize team processes

Along with establishing clear roles, there should be set team processes in place for working on a project, mitigating setbacks, communicating with each other and providing feedback.

Set defined goals

Each team should know exactly what they're working toward including what goals they need to be hitting and when.

Recognize good work

Praising and recognizing a job well done will boost confidence and morale, encouraging teams and individuals to keep up the good work.

Mediate conflict quickly and efficiently

It's normal for conflict to arise in a team setting – there may be a communication breakdown at some point or people may have personal issues. Make these practices and expectations clear from the beginning then handle situations quickly to help a team move on and maintain a good working environment.

Allow team members to actively take part in decision-making

Having a sense of personal involvement in the decision-making process will solidify individuals' connection and investment in the team, making them feel like they are an integral part of something rather than just a piece of the puzzle.

Maintain the balance of work

Of course different team members will be working on different tasks, but try to ensure that everyone still has similar workloads. There shouldn't be any single person bearing the brunt of the work.

Don't micromanage

While teams should be meeting regularly together and with their supervisors, it's still important not to micromanage. Give your team the time, space and independence to produce work on their own without feeling like they're always been watched or judged.

Start team traditions

This goes for teams and the company as a whole – create traditions to help bring people together and establish a sense of unified culture and solidarity.



Give frequent feedback

Teams should receive frequent feedback from their leaders and each other. This can mean feedback on completed work but also include sharing any questions, insight, praise or problems the team may be having.

Practical Activity # 1

Role-play for planning a shift based on priorities and workflow

		Plan business activities	
Module: 4	Learning Unit: 1	Plan work activities	
	Practical Description:	Perform role-play activity in which participants will plan a shift at a printing press by consultation amongst themselves	
Time:	4 Hours		
Equipment	n/a		
Tools	n/a		
PPE	n/a		
Materials	n/a		
Key Point	Proper consultation should be done from various workstation operators before deciding on workload		
Learning Outcome:	<ul style="list-style-type: none"> • Determine work objectives in line with organizational goals within set time frames • Establish work activity priorities and deadlines in consultation with others • Identify team roles and responsibilities • Assess resource implications of the work activities 		
Precautions:	Workload should be distributed on the basis of efficient running speeds of various workstations.		
Instructions		Illustrations	

<p>1. Determine work objectives in line with organizational goals within set time frames.</p>	<div style="text-align: right; margin-bottom: 5px;"> Process Auditor: _____ Work Cell: _____ Process Technician: _____ Team Members: _____ </div> <table border="1" style="width: 100%; border-collapse: collapse;"> <thead> <tr> <th rowspan="2">Date:</th> <th rowspan="2">Hour</th> <th colspan="4">Parts Per Hour</th> <th rowspan="2">Comments</th> </tr> <tr> <th>Plan</th> <th>Actual</th> <th>Scrap Totals</th> <th>Verified</th> </tr> </thead> <tbody> <tr><td rowspan="8" style="background-color: #4a7ebb; color: white; text-align: center; vertical-align: middle;">1st SHIFT</td><td>1</td><td></td><td></td><td></td><td></td><td></td></tr> <tr><td>2</td><td></td><td></td><td></td><td></td><td></td></tr> <tr><td>3</td><td></td><td></td><td></td><td></td><td></td></tr> <tr><td>4</td><td></td><td></td><td></td><td></td><td></td></tr> <tr><td>5</td><td></td><td></td><td></td><td></td><td></td></tr> <tr><td>6</td><td></td><td></td><td></td><td></td><td></td></tr> <tr><td>7</td><td></td><td></td><td></td><td></td><td></td></tr> <tr><td>8</td><td></td><td></td><td></td><td></td><td></td></tr> <tr><td rowspan="8" style="background-color: #4a7ebb; color: white; text-align: center; vertical-align: middle;">2nd SHIFT</td><td>1</td><td></td><td></td><td></td><td></td><td></td></tr> <tr><td>2</td><td></td><td></td><td></td><td></td><td></td></tr> <tr><td>3</td><td></td><td></td><td></td><td></td><td></td></tr> <tr><td>4</td><td></td><td></td><td></td><td></td><td></td></tr> <tr><td>5</td><td></td><td></td><td></td><td></td><td></td></tr> <tr><td>6</td><td></td><td></td><td></td><td></td><td></td></tr> <tr><td>7</td><td></td><td></td><td></td><td></td><td></td></tr> <tr><td>8</td><td></td><td></td><td></td><td></td><td></td></tr> <tr><td rowspan="8" style="background-color: #4a7ebb; color: white; text-align: center; vertical-align: middle;">3rd SHIFT</td><td>1</td><td></td><td></td><td></td><td></td><td></td></tr> <tr><td>2</td><td></td><td></td><td></td><td></td><td></td></tr> <tr><td>3</td><td></td><td></td><td></td><td></td><td></td></tr> <tr><td>4</td><td></td><td></td><td></td><td></td><td></td></tr> <tr><td>5</td><td></td><td></td><td></td><td></td><td></td></tr> <tr><td>6</td><td></td><td></td><td></td><td></td><td></td></tr> <tr><td>7</td><td></td><td></td><td></td><td></td><td></td></tr> <tr><td>8</td><td></td><td></td><td></td><td></td><td></td></tr> </tbody> </table>	Date:	Hour	Parts Per Hour				Comments	Plan	Actual	Scrap Totals	Verified	1st SHIFT	1						2						3						4						5						6						7						8						2nd SHIFT	1						2						3						4						5						6						7						8						3rd SHIFT	1						2						3						4						5						6						7						8					
Date:	Hour			Parts Per Hour					Comments																																																																																																																																																						
		Plan	Actual	Scrap Totals	Verified																																																																																																																																																										
1st SHIFT	1																																																																																																																																																														
	2																																																																																																																																																														
	3																																																																																																																																																														
	4																																																																																																																																																														
	5																																																																																																																																																														
	6																																																																																																																																																														
	7																																																																																																																																																														
	8																																																																																																																																																														
2nd SHIFT	1																																																																																																																																																														
	2																																																																																																																																																														
	3																																																																																																																																																														
	4																																																																																																																																																														
	5																																																																																																																																																														
	6																																																																																																																																																														
	7																																																																																																																																																														
	8																																																																																																																																																														
3rd SHIFT	1																																																																																																																																																														
	2																																																																																																																																																														
	3																																																																																																																																																														
	4																																																																																																																																																														
	5																																																																																																																																																														
	6																																																																																																																																																														
	7																																																																																																																																																														
	8																																																																																																																																																														
<p>2. Establish work activity priorities and deadlines in consultation with others</p>																																																																																																																																																															
<p>3. Identify team roles and responsibilities</p>																																																																																																																																																															
<p>4. Assess resource implications of the work activities</p>																																																																																																																																																															

Learning Unit - 2:

Schedule work activities

Overview: The purpose of this learning unit is to inform the learner to schedule work activities.

Organizational Policy, rules and regulation development

The following steps summaries the key stages involved in developing policies:

1. Identify need

The organization needs to constantly assess its activities, responsibilities and the external environment in order to identify the need for policies and procedures. (More on what policies you need to develop).

2. Identify who will take lead responsibility

Delegate responsibility to an individual, working group, sub-committee or staff members, according to the expertise required. (More on the management committee's role in policy development).

3. Gather information

Do you have any legal responsibilities in this area? Is your understanding accurate and up to date? Have other organizations tackled the same issue? Are there existing templates or examples that you could draw on? Where will you go for guidance?

4. Draft policy

Ensure that the wording and length or complexity of the policy are appropriate to those who will be expected to implement it.

5. Consult with appropriate stakeholders

Policies are most effective if those affected are consulted are supportive and have the opportunity to consider and discuss the potential implications of the policy.

6. Finalize / approve policy

The Management Committee is responsible for all policies and procedures within the organization.

7. Consider whether procedures are required

Procedures are more likely to be required to support internal policies. Consider whether there is a need for clear guidance regarding how the policy will be implemented and by whom.

8. Implement



How will the policy be communicated and to whom? Is training required to support the implementation among staff and volunteers?



9. Monitor, review, revise

What monitoring and reporting systems are in place to ensure that the policy is implemented and to assess usage and responses? On what basis and when will the policy be reviewed and revised (if necessary)?

Practical Activity # 2

Role-play for scheduling activities in a shift based on priorities and workflow

		Plan business activities	
Module: 4	Learning Unit: 2	Schedule work activities	
	Practical Description:	Perform role-play activity in which participants will schedule a shift on various workstations at a printing press by consultation amongst themselves	
Time:	4 Hours		
Equipment	n/a		
Tools	n/a		
PPE	n/a		
Materials	n/a		
Key Point	Proper consultation should be done from various workstation operators before deciding on workload		
Learning Outcome:	<ul style="list-style-type: none"> • Schedule work tasks • Coordinate schedule of work activities with personnel concerned 		
Precautions:	Workload should be distributed on the basis of efficient running speeds of various workstations.		
Instructions		Illustrations	
1. Verify workstation / personnel availability			
2. Consult workstation personnel/ supervisors for efficient working speed and downtimes for each workstation			

<p>3. Distribute shift time into job times for each stations considering inputs and output time for each workstation</p>	 An illustration showing a calendar with a red header 'work shifts' and a clock. A large clock face is surrounded by four stylized human figures in blue, green, yellow, and orange, representing different shifts or workers.
<p>4. Share and review the plan with team</p>	 A man in a suit stands in a room, pointing at a large wall covered in various business diagrams, charts, and icons, representing a team reviewing a plan.
<p>5. Set (Key performance Indicator) KPIs and shift-end objectives as per plan</p>	 A dashboard titled 'KEY PERFORMANCE INDICATOR' with eight colored boxes containing icons and labels: STRATEGY (green), PERFORMANCE (red), OPTIMIZATION (yellow), SUCCESS (orange), MEASUREMENT (grey), EVALUATION (green), OBJECTIVE (blue), and TEST (purple).

Learning Unit - 3:

Implement work activities

Overview: The purpose of this learning unit is to inform the learner to implement work activities.

Sharing information

For any organization, information is the most valuable asset. Since the most valuable asset is also the most widely used resource, a certain degree of security is required to guarantee the confidentiality, integrity, and availability of this information. One method of information security is to write and enforce policy which dictates the procedures for using information. Policy is a saleable security measure because it can exist at any level of an organization.

In all workgroups the employees of organizational units often need to work together and share information to accomplish their specialized functions. The trust in information sharing is so strong that if a person critical project member is absent from work, their workspace may be accessed by co-workers to retrieve data as necessary. The organization must maintain a certain level of trust for the information to be shared across the board.

Listening and understanding

Listening serves a number of possible purposes, and the purpose of listening will depend on the situation and the nature of the communication.

1. To specifically focus on the messages being communicated, avoiding distractions and preconceptions.
2. To gain a full and accurate understanding into the speakers point of view and ideas.
3. To critically assess what is being said.
4. To observe the non-verbal signals accompanying what is being said to enhance understanding.
5. To show interest, concern and concentration.
6. To encourage the speaker to communicate fully, openly and honestly.
7. To develop a selflessness approach, putting the speaker first.
8. To arrive at a shared and agreed understanding and acceptance of both sides views.

Negotiation

Negotiation involves two or more people finding an acceptable solution to a shared problem. Successful negotiators control the process, and come away with a result they're satisfied with – whether or not they've made compromises along the way.

For projects to be successful, roles, strategies, targets, and deadlines all need to be agreed, ideally to everyone's satisfaction. Negotiations are made when setting payment terms with a client, or agreeing the contract details for a new job. For better negotiation preparations here are eight factors to consider in advance:

Goals: What are you trying to achieve during the negotiation? And what do you think the other person's goals will be?

Trades: What might you be able to ask for, and what would you be prepared to give away?

Alternatives: If you really can't achieve your goals, what would be your "best alternative to a negotiated agreement?"

Relationships: How have negotiations gone with this person in the past? Just as importantly, what kind of relationship do you want with them in the future?

Expected outcomes: What precedents have been set? Based on those, and on any other evidence you have, what seems to be the most likely outcome of this negotiation?

Consequences: Is this a big, one-off deal, or one of many smaller negotiations? What do you and the other party stand to gain or lose?

Power: Who holds the power here? How might this affect the negotiation process?

Solutions: Taking all of these points into account, what do you now consider to be a fair outcome – one that you can put forward with confidence?

Facilitation and team collaboration



Without proper facilitation, even small conflicts can halt the productivity of your team or even escalate to larger issues. Facilitation is the key to concluding conflict and ensuring the parties involved can resolve conflicts without any further issues. This is why staff development is so important, to ensure that your team has the ability to overcome obstacles and conflicts in the future. A staff development programs utilizes techniques to provide unique and custom programs to help the team overcome conflict and develop deep and meaningful relationships. Some of the tools include:

- Organizational design assessments
- Facilitated discussions both on- and offsite
- Offsite events
- Teambuilding and communication programs

Practical Activity # 3

Role-play with glue binding operator for efficient working speed

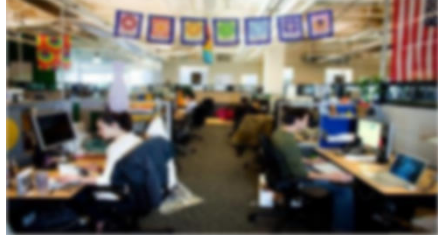
		Plan business activities	
Module: 4	Learning Unit: 3	Implement work activities	
	Practical Description:	Two participants will role-play as supervisor and operator to determine efficient working speed of a glue binding operation	
Time:	4 Hours		
Equipment	n/a		
Tools	n/a		
PPE	n/a		
Materials	Flip Chart Pen Pencil Paper Note book		
Key Point	Supervisor should be aware of the production capacity for each workstation		
Learning Outcome:	<ul style="list-style-type: none"> Identify work methods and practices in consultation with personnel concerned. Implement work plans in accordance with set time frames, resources and standards. Conduct work within established workplace policies and the business goals of the workplace 		
Precautions:	Always keep safety net from the operators narrated production capacity		
Instructions		Illustrations	
1. Identify objectives			

<p>2. Consult workstation personnel/ supervisors for efficient working speed and downtimes for each workstation</p>	
<p>3. Distribute shift time into job times for each stations considering inputs and output time for each workstation</p>	
<p>4. Share and review the plan with team</p>	
<p>5. Set (Key performance Indicator) KPIs and shift-end objectives as per plan</p>	

Learning Unit – 4 & 5:

Monitor work activities

Review and evaluate work plans and activities

Overview: The purpose of this learning unit is to inform the learner to monitor, review and evaluate work plans and activities.

Conducting team meetings

Effective meetings are interesting, high-energy events where team members work together to make decisions or solve problems. Unfortunately, too many of the meetings we attend seem to be just the opposite. The worst meetings bring time to a crawl leaving everyone mentally and emotionally exhausted and more than a little bit frustrated. The difference is in how the meetings are planned and run.

The best managers understand the importance of these events, and they understand that producing a great meeting takes planning and deliberate effort. Here are tips on how to strengthen your team meetings.

Have a Positive Attitude about Meetings

It is the single most important thing a manager can do as a leader to improve team meetings. It's surprising how many managers are proud to proclaim their dislike of meetings, but to achieve significant results, solve problems, make decisions, inform, inspire, collaborate, and motivate, managers need to work with people.

Remember, You Own the Meeting

Don't delegate the agenda planning to an administrative assistant or another team member. As the leader, it's your meeting to plan and run. To put yourself in the proper frame of mind, ask and answer the following question: "After this meeting, what will I want people to have learned, achieved or solved?"

Always Prepare an Agenda

Everything you will ever read about effective workplace meetings includes advice on preparing an agenda. Yet, we've all shown up to a meeting where there is no agenda to be found. The act of planning the agenda helps to focus and identify the priority topics for the meeting.

Ask for Input on the Agenda

Although it's the manager's primary responsibility to develop the agenda, team members can be invited to contribute agenda items. Send out a call for ideas a few days before the meeting.

Use Team Meetings to Collaborate

Instead of just sharing information, try solving a problem or working with the group on arriving at a decision. Yes, it's challenging and can be messy, but that's where we get the most value from meetings.

Lighten Up

Being the leader of a meeting isn't about flaunting authority or abusing power. Chastising someone for being late in front of the team is an example of doing this. Keep a sense of humor and your humility.

Follow-Up

Keep track of action items and make sure people do what they say they are going to do. It's frustrating to show up at the next meeting and find out half the team didn't bother doing what they committed to in the last meeting. Follow up before the meeting and hold individuals accountable for their commitments.

Be a Role Model Leader

Team meetings are not a time to let your guard down and kick back with your team. Hold yourself and your team to the highest standards of conduct, which means no off-color jokes, picking on team members, cynicism and sarcasm, or bashing other departments or management. Think about the kind of leader you want to be known as, and then show up to each and every meeting being that leader.

The Bottom Line

An opportunity to meet and work with your team is a horrible thing to waste. It is imperative that you develop the discipline to plan and lead meetings that people value and push initiatives forward.

Team dynamics and facilitation processes

People often take on distinct roles and behaviors when they work in a group. "Group dynamics" describes the effects of these roles and behaviors on other group members, and on the group as a whole.

A group with a positive dynamic is easy to spot. Team members trust one another, they work towards a collective decision, and they hold one another accountable for making things happen. As well as when a team has a positive dynamic, its members are nearly twice as creative as an average group.

In a group with poor group dynamics, people's behavior disrupts work. As a result, the group may not come to any decision, or it may make the wrong choice, because group members could not explore options effectively.

Group leaders and team members can contribute to the group dynamic. Let's look at some of the most common problems that can occur:

Weak leadership: when a team lacks a strong leader, a more dominant member of the group can often take charge. This can lead to a lack of direction, infighting, or a focus on the wrong priorities.

Excessive deference to authority: this can happen when people want to be seen to agree with a leader, and therefore hold back from expressing their own opinions.

Blocking: this happens when team members behave in a way that disrupts the flow of information in the group.

Groupthink: this happens when people place a desire for consensus above their desire to reach the right decision. This prevents people from fully exploring alternative solutions

Group dynamics can be improved by:

Knowing Your Team Well

As a leader, you need to guide the development of your group. So, start by learning about the phases that a group goes through as it develops. When you understand these, you'll be able to preempt problems that could arise, including issues with poor group dynamics.

Tackle Problems Quickly

If you notice that one member of your team has adopted a behavior that's affecting the group unhelpfully, act quickly to challenge it.

Define Roles and Responsibilities

Teams that lack focus or direction can quickly develop poor dynamics, as people struggle to understand their role in the group.

Break Down Barriers

Use team-building exercises to help everyone get to know one another, particularly when new members join the group. These exercises ease new colleagues into the group gently, and also help to combat the "black sheep effect," which happens when group members turn against people they consider different.

Focus on Communication

Open communication is central to good team dynamics, so make sure that everyone is communicating clearly and avoid any ambiguity and ensure that everyone has the same information.

Pay Attention

Watch out for the warning signs of poor group dynamics. Pay particular attention to frequent unanimous decisions, as these can be a sign of groupthink, bullying, or free riding. If there are frequent unanimous decisions in your group, consider exploring new ways to encourage people to discuss their views, or to share them anonymously.

Motivation skills

Successfully motivating others is an important skill. Organizations can use motivation skills to increase their chances of getting positive results when interfacing with customers, subordinates, upper management, suppliers, donors, team members, funding sources and supervisors. For managers, who must inspire a whole team, the ability to motivate is usually a requirement.

Motivational skills can be defined as actions or strategies that elicit a desired behavior or response from a stakeholder. These strategies and actions vary based on three major factors:

10. The motivator's style
11. The target audience
12. The personality of the person the motivator seeks to influence

Motivation is a process that requires careful strategy for success. These steps can help you to reach the desired outcome:

- Assess the preferences and personality characteristics of the individual or group to be motivated. What motivates one group of people might not be the same as what motivates another group of people.
- Convey expectations for performance from the object of the motivation. Or, make it clear how the person can achieve the desired outcome.
- Communicate benefits, rewards, or sanctions if expectations are or are not met.
- Share feedback on progress or lack of progress toward desired outcomes.
- Address problems or obstacles that are limiting success.
- Provide rewards for desired outcomes.
- Issue warnings before enacting sanctions.
- Recognize people who have responded in the desired manner.

Outline organizations policies, strategic plans, guidelines related to the role of the work unit

Defining the roles and responsibilities of members in your organization is important for several reasons:

Hiring the right people for the job

From the beginning, having clearly defined roles will enable management to identify the type of people they will need, so they can proceed to targeting and hiring the most qualified candidates for the job.

Improved collaboration

If each employee's role and responsibilities are defined clearly, there are higher chances of collaboration and sharing of work becoming more successful. This also works clearly when you have different groups of people working together. It is not enough that you have clearly defined the roles and responsibilities of each group; you

should also make sure that their individual roles are just as definite, since it makes for better teamwork if each employee is aware of what they are bringing to the table and what is expected of them. This will also reduce the possibilities of misunderstandings and disputes, especially those that are related to authority.

Development of strong teams

Teamwork is one of the vital ingredients in organizational success, and strong teams are composed of individuals who know what they are supposed to do, and what they are responsible for. If management is able to communicate to its teams and team members their responsibility and accountability properly, then they will have stronger teamwork, leading to higher productivity and better results.

Improved overall effectiveness and efficiency





All the above will result in higher efficiency and effectiveness in how the business is run. Finding a good fit or match between jobs and people will lessen and even eliminate errors and mistakes, and improve quality of work. There will be lesser instances of delays and backlogs brought about by misunderstanding when it comes to roles of employees, and they will have a strong sense of responsibility towards their job and the organization.

Redundancies are also avoided, and job distribution will be improved. For example, they might discover that one person is currently doing the work of three people, while three people are doing practically the same thing. In the long run, these could result in cost savings for the organization and a more efficient use of its resources.

Practical Activity # 4

Analyze operation reports

Plan business activities	
Module: 4	Learning Unit: 4-5 Monitor work activities Review and evaluate work plans and activities
	Practical Description: Read and evaluate various operation report of each workstation
Time:	8 Hours
Equipment	n/a
Tools	n/a
PPE	n/a
Materials	Flip Chart Pen Pencil Paper Note book
Key Point	Supervisor should be aware of the production capacity for each workstation
Learning Outcome:	<ul style="list-style-type: none"> • Monitor work activities and compare with set objectives. • Monitor work performance • Report and coordinate deviations from work activities with appropriate personnel and in accordance with set standards. • Compile reporting requirements with in accordance with recommended format. • Maintain files in accordance with standard operating procedures. • Review work plans, strategies and implementation based on accurate, relevant and current information. • Base the review on comprehensive consultation with appropriate personnel on outcomes of work plans and reliable feedback. • Get the feedback to identify and develop ways to improve competence within available opportunities.
Precautions:	Always keep safety net from the operators narrated production capacity
Instructions	Illustrations

<p>1. Identify organizational goals</p>	
<p>2. Collect various workstation reports and analyze them for efficient working procedures</p>	
<p>3. Find operational bottlenecks</p>	
<p>4. Make operational plan to remove bottlenecks and smooth process</p>	<p>OPERATIONAL PLAN Operational Planning & Control</p> 
<p>5. Share and review the plan with team</p>	
<p>6. Set (Key performance Indicator) KPIs and new organization objectives as per plan</p>	

Summary of the Module

In the Module of Manage a team the following topics have been covered

- Plan work activities
- Schedule work activities
- Implement work activities
- Monitor work activities Review and evaluate work plans and activities

In the above mentioned topics some critical areas also briefed like

Basic rules of Planning & organizing

Scheduling steps

Implementation rules and strategies

- Sharing information
- Listening and understanding
- Negotiation
- Facilitation and team collaboration

Monitoring and evaluation

- Conducting team meetings
- Team dynamics and facilitation processes
- Motivation skills

Frequently Asked Questions (FAQs)

Question	Answer
1. Why do businesses have a plan for everything?	Business is a complex operation which has many variables; planning helps analyze the variables to make informed decisions.
2. What is micro-management?	The act of managing operation after delegation is micro management.
3. What is feedback?	To give an honest opinion about something you have observed or been a part of is called your feedback.
4. What if a planned job's raw material is not available?	A requisition must be made to procure the required materials based on organizational requirement.
5. What is the difference between schedule and timetable?	Timetable is repetitive whereas a schedule is for a particular activity only.
6. Why is it important to share management plans with employees?	In order to get their feedback on the correctness of the plan, the plan should be shared with as many people as possible without compromising integrity of information.
7. Does being an effective negotiator means to be able to take others share?	A good project deal does not necessarily means ones loss is others gain. Good negotiators always come up with win-win solutions.
8. Why do businesses waste time and money on meetings when you can be productive during these times?	Meetings are not a waste of time; in fact they can save the company many folds in opportunity cost when everyone is aligned to a single objective.

Self-Assessment

(MCQs)

Please mark the correct one from the given options. You can check your answer with the Answer Key at the end of this module

1. What kind of activity is 'Defining business goals'?
 - a. Production
 - b. Organizing
 - c. Efficient
 - d. Emotional

2. Where are all the pre-press raw materials available?
 - a. Warehouse
 - b. Super store
 - c. In the floor tiling
 - d. Outer space

3. What is made by writing activities in chronological order?
 - a. Organization chart
 - b. Job card
 - c. Schedule
 - d. Roles

4. What is a policy?
 - a. A set of rules
 - b. An insurance brand
 - c. A cola brand
 - d. A type of management

5. What is the distribution of shift time into job times for each stations considering inputs and output time for each workstation?
 - a. KPI
 - b. Shift plan
 - c. Vision
 - d. Net profit

6. To understand what is being said we should?
 - a. Shout
 - b. Plan
 - c. Listen
 - d. Read

7. What is a meeting where terms of agreement are discussed?
 - a. Planning meeting
 - b. Hotel meeting
 - c. Tea meeting
 - d. Negotiation

8. The goal of a leader is to help the organization stay competitive by team building and facilitation
- True
 - False
9. What should be your attitude towards team meeting?
- Look forward for food
 - Not pay attention
 - Have a positive attitude
 - Have a negative attitude
10. A team with negative team dynamics trusts each other.
- True
 - False

Answer Key

MCQ No.	Correct Answer
1	B
2	A
3	C
4	A
5	B
6	C
7	D
8	A
9	C
10	B

POST PRESS OPERATIONS (Publishing)

Learner Guide

National Vocational
Certificate Level 5

Version 1 - December 2019

Module-5

Module 5: - Address Basic Customer needs

Learning Unit:

After completion of this module the learner will be able to:

LU1: Assist customer to articulate needs

LU2: Satisfy customer needs

LU3: Manage networks to ensure customer needs are addressed

LU4: Convert customer enquiries into sales

Learning Unit – 1 & 2:

Assist customer to articulate needs

Satisfy Customer needs

Overview: The purpose of this learning unit is to inform the learner to ensure customer needs are fully understood, match available services and products, identify and communicate rights and responsibilities of customers.

Explain organizational procedures and standards for establishing and maintaining customer service relationships

A customer is the recipient of a good, service, product or an idea - obtained from a seller, vendor, or supplier via a financial transaction or exchange for money or some other valuable consideration. A customer becomes a consumer once the recipient begins to use the product or service. A client is a recipient who buys services from an organization, particularly a professional service.

Organizations can have internal and external customers. An example of an internal customer is a department in an organization that receives services from another department. For example, the Binding Department might get its inputs from the printing department. An example of an external customer is a person who buys shoes from a shoe store.

What Customers Value

There is a difference between knowing the needs of customers compared to actually meeting their needs. To begin meeting those needs, it is important to consider what different types of customers typically value in meeting their own needs. To some customers, value is the lowest price. To others, value represents prestige. To others, it represents long-lasting quality. What do your customers value the most from the products and services? How does that value differentiate you from your competitors?

What is Customer Service?

In the past, customer service usually meant being understanding and courteous to your customers while they were buying your product. However, today's customers are much more demanding and competition is much stronger. Consequently, it is much more useful to consider customer service to be the type of support that you offer before, during and after your customers buy from you. Many companies today are highly competitive primarily because of the very high quality of their customer service.

PREPARE FOR PROVIDING STRONG CUSTOMER SERVICE

The implementation of the guidelines in each this section should be managed by an Implementation Team comprised of at least one member from general management, and management in the functions of sales, marketing and customer service.

Be Systematic in Your Planning

Strong customer service is so vital to the surviving -- and thriving -- of your organization that it should not be done in a reactive and sporadic approach. Instead, it needs to be done proactively from a well-designed customer service management plan.

Establish Customer Service Goals

Consider your organization's overall strategic priorities. For example, does your organization want especially to increase sales and profits, increase impact in the community (if yours is a nonprofit), expand market share and/or reduce customer complaints? Then consider the different types of customers that you have (market segments) and how you want to manage each differently in order to help achieve your organization's goals. For example, do you want to focus even more on the most profitable customers? Reduce the types that generate the least revenues? Expand marketing to new customers to expand market share? Then consider where to focus in your customer service activities in each group. For example, better tools to get feedback from customers, starting a call center, starting a new customer service manager position and/or use more social media?

Be Realistic In Your Planning

Especially if yours is a small to medium-sized organization, or if this is your first time in being focused and intentional about customer service, then be very realistic about your planning. For the first draft of your plan, focus on its most basic elements and then embellish the plan as you implement the plan during its first year.

SATISFY YOUR CUSTOMERS

Clearly Identify Customers' Needs

One of the biggest mistakes that an organization can make is to assume that all of its customers are the same. The power of excellent sales, marketing and customer service comes from realizing that different types of customers have different types of needs. Do you have different groups of customers who have different needs? How do you know? Do some need prompt provision of products rather than ordering online? Self-maintenance rather than ongoing support? Basic functionality rather than high-quality?

Meet Customers' Needs

Different market segments have different needs. They have different interpretations of value -- of what will meet their needs. To remain viable, your organization has to be meeting the different needs of its different market segments. How do you best meet the needs of each different market segments? How do you know?

Get Customers' Feedback

The way to ensure that your organization is meeting the needs of its customers comes especially from their feedback. According to Barb Lyon, there are many different ways to ask: post-purchase and post-support surveys, enclosures in the monthly invoice, follow-up phone calls and quarterly or annual surveys. Each different market segment might prefer different measures. How are you getting feedback from each of your different groups of customers? Is feedback actively solicited or informally collected? What are you hearing from each different market segment? How do you respond to what you are hearing?

Measure Customers' Satisfaction

There are numerous different ways to measure the satisfaction of your customers. The challenge with specifying key measures is that not all businesses will use the same metrics. According to Barb Lyon, for call centers, support, and service desks, first call resolution is the Holy Grail. For a shipping operation, product delivery and project implementation, on-time performance is the measuring stick. In a high transaction business, the first interaction with a customer will be a key determinant of whether the customer will return. How should you measure satisfaction for each of your different market segments?

RETAIN YOUR CUSTOMERS

Retention is primarily a result of customer loyalty. What should you be doing to retain the customers in each of your different market segments?

Manage Customers' Complaints

While some organizations consider customer complaints to be signs of failure, others see them as opportunities to learn from. Also, research suggests that customers who experience prompt resolution to their complaints often are some of the most loyal customers. However, there are some best practices in handling complaints that you should be aware of. How are you handling complaints to each of your different market segments? Is that the best approach for each? How do you know?

Manage Customer Relationships

You can understand why the most important aspect between your organization and its customers is the quality of the relationship between the organization and its customers. That quality determines how loyal your customers are to your organization. Fortunately, there has been an increasing amount of research about best practices to manage the relationships. The field has come to be known as Customer Relationship Management (CRM). Various software packages make it much easier to collect, organize and reference a vast range of information about customers. CRM has been proven to increase the number of customers and profitability for organizations.

Informed consent

For vendors, customers need to give informed consent to use their information in order to get the required product of service. There are 4 components of informed consent:

- Customer must have the capacity (or ability) to make the decision.
- Disclosure to information must be ensured
- Customers must comprehend the relevance information
- Customers must voluntarily grant consent, without coercion or duress

Describe ways to establish effective regular communication with customers

Have the same person work with specific customers. Customers are more likely to have an engaging conversation with someone they've spoken to before. Creating a level of comfort with customers is ideal for maintaining strong communications.

Personalize the interaction by ensuring sales personnel complete up-front work. Make sure there is an understanding of the prep work required before they respond to a customer. By keeping a thorough activity log and utilizing customer service integrations, it's easy to avoid repetitive information requests.



Have sales personnel be quick with responses and show genuine interest. Try to avoid those dreadful scripted conversations with long pauses and avoid putting the customer on hold as much as possible. These wait times can be alleviated with an intuitive customer service log that displays an abundance of company information in one place. Having everything right in front of you makes it easier to quickly find the information you need.

Always try to keep the conversation alive with follow up interactions. Especially for large customers and/or important conversations, instruct agents to say they'll send over a recap of what was discussed. Not only are you making the customer's life easier, but here you can ask any relevant follow-up questions to keep the dialogue going. A recap is also a great way to ask for feedback on their experience with your business. This is an excellent communication tactic as it generates yet another opportunity for customers to be heard.

Practical Activity # 1

Make CRM strategy

Address Basic Customer needs	
Module: 5	Learning Unit: 1-2 Assist customer to articulate needs Satisfy Customer needs
	Practical Description: Make new CRM strategy for your organization according to organizational goals
Time:	12 Hours
Equipment	n/a
Tools	n/a
PPE	n/a
Materials	n/a
Key Point	Distinction must be made between quality and quantity of customers
Learning Outcome:	<ul style="list-style-type: none"> • Ensure customer needs are fully explored, understood and agreed • Explain and match available services and products to customer needs • Identify and communicate rights and responsibilities of customers to the customer as appropriate • Explain possibilities for meeting customer needs • Assist customers to evaluate service and/or product options to satisfy their needs • Determine and prioritize preferred actions • Identify potential areas of difficulty in customer service delivery • Take appropriate actions in a positive manner
Precautions:	Before starting a new customer relationship we must understand their business practices
Instructions	Illustrations

<p>1. Understand organizational vision, mission and objectives</p>	
<p>2. Survey current customers for discrepancies and feedback</p>	
<p>3. Explore possibilities of operational expansion based on customer feedback</p>	
<p>4. Re-write customer contracts based on new services and products</p>	

Learning Unit - 3:

Manage networks to ensure customer needs are addressed

Overview: The purpose of this learning unit is to inform the learner to manage networks to ensure customer needs are addressed.

Explain consumer rights and responsibilities







A customer has the following rights and responsibilities:

- Customer has the Right to be treated with respect
- Customer has Right to be heard
- Customer has Right to Privacy
- Customer has Right to decide which service to use
- Customer has Right to receive clear, truthful and timely information
- Customer has Responsibility to treat individuals with respect
- Customer has Responsibility to evaluate the costs of a product
- Customer has Responsibility to comply with the terms and conditions of the
- Customer has Responsibility to provide truthful and timely information
- Customer has Responsibility to protect other people's personal sensitive

Practical Activity # 2

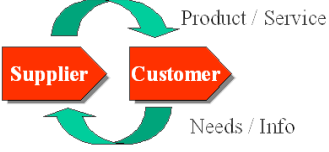
Role-play as service provider and long term customer

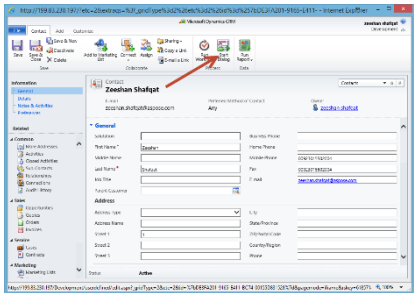
		Address Basic Customer needs	
Module: 5	Learning Unit: 3	Manage networks to ensure customer needs are addressed	
	Practical Description:	Perform a role-play activity among students to interview a long term customer for feedback	
Time:	6 Hours		
Equipment	n/a		
Tools	n/a		
PPE	n/a		
Materials	n/a		
Key Point	Sensitive information about customer business must not be discussed		
Learning Outcome:	<ul style="list-style-type: none"> • Establish effective regular communication with customers • Obtain customer feedback about the products/services rendered • Ensure referrals are based on the matching of the assessment of customer needs and availability of products and services • Maintain records of customer interaction in accordance with organizational procedures 		
Precautions:	Future organization plans must only be shared with potential customer for feedback		
Instructions		Illustrations	
1. Analyze customer history/records before starting the interview			

<p>2. Greet the customer well and minimize small talk</p>	 <p>www.shutterstock.com + 402366421</p>
<p>3. Ask the customer about current services and products and their feedback on each of them</p>	
<p>4. Ask the customer for the management personnel feedback</p>	
<p>5. Ask the customer about the other suppliers they are working with</p>	
<p>6. Why customer prefer one supplier over the other</p>	
<p>7. Record interview answers in CRM documents</p>	
<p>8. Review CRM documents and consult them when planning annual organizational objectives</p>	

Learning Unit - 4:

Convert customer enquiries into sales

Overview: The purpose of this learning unit is to inform the learner to convert customer enquiries into sales.

Outline details of products or services

One of the toughest problems in B2B marketing is writing a concise description of a product or service that truly resonates with the target market. The difficulty isn't in describing the product or service and what it does. The difficulty lies in finding the right words to make that description concise, yet compelling to your prospects, so they'll immediately grasp your solution's importance to them.







The key to making your description compelling is by mentioning the benefits and features institutional customers will want to know as much about the features as about the benefits. You need to give them equal weight.

1. Write a very short paragraph describing the prospect's main challenge that the product or service addresses.
2. Write a concise paragraph that describes what the product or service is, and how it addresses the challenge described in the opening paragraph.
3. Write another short paragraph that shows prospects what using the product or service will mean to them, highlighting additional benefits and mentioning features where necessary.

Practical Activity # 3

Role playing activity

Address Basic Customer needs	
Module: 5	Learning Unit: 4 Convert customer enquiries into sales
	Practical Description: Role playing activity pitching new product and services to a potential customer
Time:	8 Hours
Equipment	n/a
Tools	n/a
PPE	n/a
Materials	n/a
Key Point	The potential customer must have a need for our product
Learning Outcome:	<ul style="list-style-type: none"> • use information accessed from the customer relationship management (CRM) system to identify any needs • identify suitable products/services to meet needs • make convincing sales pitches to customers following standard scripts • handle customer queries, objections and rebuttals following standard scripts • adapt approach according to the customer preferences • Report issues to concerned authorities • Obtain customer's financial information as per organization policy • Complete post-sales procedures to complete sales
Precautions:	Information requested from the potential customer should not be confidential
Instructions	Illustrations

<p>1. Use your professional network to find out potential customers</p>	
<p>2. Book an appointment at least 2 days in advance with relevant personnel</p>	
<p>3. Prepare in an organizational introduction including product and services offered and current customer list</p>	
<p>4. Ask for problems that are faced in post-press operations</p>	
<p>5. Propose how your product and services can help them overcome their problems</p>	
<p>6. Prepare feasibility plan for the new customer</p>	

Summary of the Module

In the Module of address basic customer needs the following topics have been covered.

- Assist customer to articulate needs
- Satisfy customer needs
- Manage networks to ensure customer needs are addressed
- Convert customer enquiries into sales

In the above mentioned topics some critical areas also briefed like

Customer satisfaction

- Clearly Identify Customers' Needs
- Meet Customers' Needs
- Get Customers' Feedback
- Measure Customers' Satisfaction
- RETAIN YOUR CUSTOMERS
- Manage Customers' Complaints

Customer service and relation

- Customer values
- Systematic in Your Planning
- Establish Customer Service Goals

Describe ways to establish effective regular communication with customers

Consumer rights and responsibilities

Outline details of products or services

Frequently Asked Questions (FAQs)

Question	Answer
1. Why should we learn the types of customer?	It is important to know what type of customer you are dealing with so that you can offer them solutions according to their needs.
2. Why is customer service important in business?	Proper customer service ensures customer satisfaction and reinforces customer loyalty
3. How can servicing current customers can increase your prospect with potential customers?	There are many ways to increase your prospect with a potential customer especially for B2B market including word of mouth.
4. How can we have informed consent for information?	When the customer is satisfied with your information handling the information sharing consent will be easy to achieve.
5. What is CRM?	Customer Relationship Management
6. What is the moral limit in meeting customer needs?	Moral limits are defined by the society, industry and the person himself but meeting customer needs should not force you to compromise on your values ever.
7. Why are we learning the rights of customers?	There are two aspects; firstly, you are also the customer to someone so that helps you, secondly, in order to fulfill your responsibilities, you should know what you are obliged to do for the customer

Self-Assessment

(MCQs)

Please mark the correct one from the given options. You can check your answer with the Answer Key at the end of this module

- Q 1. Market offering that is essentially intangible is called
- Services
 - Products
 - Commodity
 - Competitive Edge
- Q 2. According to service quality model, willingness of employees to solve problems of customers is classified as
- Responsiveness
 - Assurance
 - Empathy
 - Reliability
- Q 3. Asking your customer questions:
- Means you will lose control of the call.
 - Is a waste of time.
 - Helps you understand their needs.
 - Doesn't work in sales.
- Q 4. When we meet our customer's needs, we:
- We build relationships.
 - We establish rapport.
 - We create loyal customers.
 - All of the above.
- Q 5. After asking our customers a question, what is the most important thing to do?
- Close the sale.
 - Actively listen to their answer.
 - Ask another question.
 - Make a sales pitch
- Q 6. _____ is a person's feelings of the result from evaluating a product's perceived performance to their expectations.
- Customer loyalty
 - Customer satisfaction
 - Customer value
 - None of the above
- Q 7. Increasing customer satisfaction is leading to customer loyalty.
- True
 - False

- Q 8. Companies can know about customer satisfaction by customer survey.
- True
 - False
- Q 9. _____ is the characteristics and features of a service or product that bear on its ability to satisfy customer needs.
- Quality
 - Satisfaction
 - Value
 - Loyalty
- Q 10. What does CRM stand for?
- Consumer Recruitment Management
 - Customer Retailing Management
 - Customer Resource Management
 - Customer Relationship Management

Answer Key

MCQ No.	Correct Answer
1	A
2	A
3	C
4	D
5	B
6	B
7	A
8	A
9	A
10	D

POST PRESS OPERATIONS (Publishing)

Learner Guide

National Vocational
Certificate Level 5

Version 1 - December 2019

Module-6

Module 6: - Manage Human Resources

Learning Unit:

After completion of this module the learner will be able to:

LU1: Determine human resource requirements

LU2: Establish productive team relationships

LU3: Monitor Human Resource Management

LU4: Contribute to evaluate human resource practices.

Learning Unit - 1:

Determine human resource requirements

Overview: The purpose of this learning unit is to inform the learner to analyze work breakdown structure and prepare skills analysis of project personnel.

Identify alternative project personnel engagement options

Project Human Resource Management includes the processes that organize, manage, and lead the project team. The project team is comprised of the people with assigned roles and responsibilities for completing the project. Project team members may have varied skill sets, may be assigned full or part-time, and may be added or removed from the team as the project progresses. Project team members may also be referred to as the project's staff. Although specific roles and responsibilities for the project team members are assigned, the involvement of all team members in project planning and decision making is beneficial. Participation of team members during planning adds their expertise to the process and strengthens their commitment to the project.

Acquire Project Team—The process of confirming human resource availability and obtaining the team necessary to complete project activities.

Develop Project Team—The process of improving competencies, team member interaction, and overall team environment to enhance project performance.

Manage Project Team—The process of tracking team member performance, providing feedback, resolving issues, and managing changes to optimize project performance.

Develop Human Resource Plan

Developing the human resource plan includes the major headings listed below, along with a brief description of what is expected for each.

Roles and Responsibilities - can be assigned to a person or group. This defines roles, authority, responsibility, and competency. These individuals or groups can be within or outside the performing organization. The roles described for the project may not have a direct analog to a position within the organization. Thus it is the project manager's job to identify resources that can take on the responsibilities of the particular role needed for the project.

Org Charts - an organizational breakdown chart (OBS) is critical for identifying management hierarchies in the project and identifying potential escalation paths should there be issues that the project manager has not been empowered to resolve. In a matrix organization this becomes a critical factor, as it may identify functional managers from whom the project manager secures resources for the project. The org chart also works hand-in-hand with a roles and responsibilities chart, in that it will identify an unambiguous owner for each work package in the project.

Staffing Management Plan - this plan describes how human resource requirements will be met for the project. The plan can be formal or informal, detailed or general, depending on the project needs. The staffing management plan is continually updated during the project and usually includes the following elements:

Staff Acquisition - identifies when specific resources roll on or off the project and the skill levels required of those resources

Resource Calendars - identifies when staff acquisition activities should begin as well as staff availability and hours available from a particular resource

Staff release plan - defines when resources are released from the project so that those resources are no longer charged to the project

Training - may be required if the performing organization is dealing with a new or untried technology. It is also beneficial in that it will help team members attain certifications that support their ability to meet project requirements. In PMI's view, training is not used as a 'perk'.

Recognition and Rewards - the idea of a recognition and reward system is that it tends to promote desired behavior on the project.





Compliance - this involves compliance with government regulations or union contracts in addition to established human resource policies

Safety - these include methods and procedures that are designed to protect team members from the potential safety hazards. These elements are not only included in a staffing management plan, but can also be included in the risk register

Practical Activity # 1

Role-play activity for work breakdown meeting

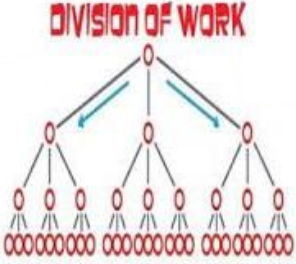
		Manage Human Resources	
Module: 6	Learning Unit: 1	Determine human resource requirements	
	Practical Description:	Perform a role-play activity performing work breakdown meeting	
Time:	06 Hours		
Equipment	n/a		
Tools	n/a		
PPE	n/a		
Materials	n/a		
Key Point	Projects should be prioritized based on organizational requirements		
Learning Outcome:	<ul style="list-style-type: none"> Analyze work breakdown structure to determine human resource requirements Prepare a skills analysis of project personnel against project task requirements Assist in assigning responsibilities for achieving project deliverables 		
Precautions:	Project timeline must be strictly followed		
Instructions		Illustrations	
1. Evaluate project brief and related documents			

<p>2. Make project tasks and associated timelines</p>	
<p>3. Assess resource requirements</p>	
<p>4. Determine budgetary requirements</p>	
<p>5. Create work divisions and subdivisions based on the collected information</p>	
<p>6. Share deliverables and sub-deliverables with project team</p>	
<p>7. Consult with all relevant parties prior to finalizing draft plan, make changes as appropriate</p>	

Learning Unit - 2:

Establish productive team relationships

Overview: The purpose of this learning unit is to inform the learner to seek views, promote cooperation, communicate with others, communicate ideas, and seek for feedback on regular basis.

Explain job design principles and work breakdown structures

A work breakdown structure (WBS) is a key project deliverable that organizes the team's work into manageable sections. The Project Management Body of Knowledge (PMBOK) defines the work breakdown structure as a "deliverable oriented hierarchical decomposition of the work to be executed by the project team." The work breakdown structure visually defines the scope into manageable chunks that a project team can understand, as each level of the work breakdown structure provides further definition and detail.

An easy way to think about a work breakdown structure is as an outline or map of the specific project. A work breakdown structure starts with the project as the top level deliverable and is further decomposed into sub-deliverables.

The project team creates the project work breakdown structure by identifying the major functional deliverables and subdividing those deliverables into smaller systems and sub-deliverables. These sub-deliverables are further decomposed until a single person can be assigned. At this level, the specific work packages required to produce the sub-deliverable are identified and grouped together. The work package represents the list of tasks or "to-dos" to produce the specific unit of work. If you've seen detailed project schedules, then you'll recognize the tasks under the work package as the "stuff" people need to complete by a specific time and within a specific level of effort.

From a cost perspective, these work packages are usually grouped and assigned to a specific department to produce the work. These departments, or cost accounts, are defined in an organizational breakdown structure and are allocated a budget to produce the specific deliverables. By integrating the cost accounts from the organizational breakdown structure and the project's work breakdown structure, the entire organization can track financial progress in addition to project performance.

Why use a Work Breakdown Structure?

The work breakdown structure has a number of benefits in addition to defining and organizing the project work. A project budget can be allocated to the top levels of the work breakdown structure, and department budgets can be quickly calculated based on the each project's work breakdown structure. By allocating time and cost estimates to specific sections of the work breakdown structure, a project schedule and budget can be quickly developed. As the project executes, specific sections of the work breakdown structure can be tracked to identify project cost performance and identify issues and problem areas in the project organization. For more information about Time allocation, see the 100% Rule.

Project work breakdown structures can also be used to identify potential risks in a given project. If a work breakdown structure has a branch that is not well defined then it represents a scope definition risk. These risks should be tracked in a project log and reviewed as the project executes. By integrating the work breakdown structure with an organizational breakdown structure, the project manager can also identify communication points and formulate a communication plan across the project organization.

When a project is falling behind, referring the work breakdown structure will quickly identify the major deliverables impacted by a failing work package or late sub-deliverable. The work breakdown structure can also be color coded to represent sub-deliverable status. Assigning colors of red for late, yellow for at risk, green for on-target, and blue for completed deliverables is an effective way to produce a heat-map of project progress and draw management's attention to key areas of the work breakdown structure.

Work Breakdown Structure Guidelines

The following guidelines should be considered when creating a work breakdown structure:

- The top level represents the final deliverable or project
- Sub-deliverables contain work packages that are assigned to a organization's department or unit
- All elements of the work breakdown structure don't need to be defined to the same level
- The work package defines the work, duration, and costs for the tasks required to produce the sub-deliverable
- Work packages should be independent of other work packages in the work breakdown structure
- Work packages are unique and should not be duplicated across the work breakdown structure







Tools to Create a Work Breakdown Structure

Creating a Work Breakdown Structure is a team effort and is the culmination of multiple inputs and perspectives for the given project. One effective technique is to organize a brainstorming session with the various departments that will be involved with the project. Project teams can use low-technology tools like a white board, note cards, or sticky note pads to identify major deliverables, sub-deliverables, and specific work packages. These cards can be taped to a wall and reorganized as the team discusses the major deliverables and work packages involved in the project.

Practical Activity # 2

Role-play activity for day meeting

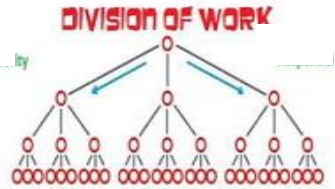
		Manage Human Resources	
Module: 6	Learning Unit: 2	Establish productive team relationships	
	Practical Description:	Perform a role-play activity performing a production meeting at day-end	
Time:	06 Hours		
Equipment	n/a		
Tools	n/a		
PPE	n/a		
Materials	n/a		
Key Point	Meeting agenda must be carefully defined		
Learning Outcome:	<ul style="list-style-type: none"> • Actively seek views and opinions of team members during task planning and implementation • Promote cooperation and effective activities, goals and relationships within team • Communicate with others using styles and methods appropriate to organizational standards, group expectations and desired outcomes • Communicate information and ideas to others in a logical, concise and understandable manner • Regularly seek feedback on nature and quality of work relationships, and use feedback as basis for own improvement and development 		
Precautions:	Meeting times must be strictly followed		
Instructions		Illustrations	

<p>1. Ask participants for views and opinions of team members on planning and implementation</p>	
<p>2. Reinforce cooperation and effectiveness within team</p>	
<p>3. Communicate with team using styles and methods appropriate to organizational standards, group expectations and desired outcomes</p>	
<p>4. Communicate information and ideas to others in a logical, concise and understandable manner</p>	
<p>5. Create work divisions and subdivisions based on the collected information</p>	
<p>6. Collect feedback 7. Finalize plan</p>	

Learning Unit – 3 & 4:

Monitor Human Resource Management

Contribute to evaluate human resource practices

Overview: The purpose of this learning unit is to inform the learner to use proper tools in monitoring human resource management and contribute to evaluate human resources practices.

List methods for skill gap analysis

A skills gap is the difference between skills that employers want or need, and skills their workforce offer. Conducting a skills gap analysis helps you identify skills you need to meet your business goals. It can also inform your employee development and hiring programs.

Here's how to conduct a skills gap analysis:

Step 1: Plan

You can perform a skills gap analysis on two levels:

Individual: You can identify the skills a job requires and compare them to an employee's actual skill level.

Team/company: You can determine if your employees have the skills to work on an upcoming project or if you need to hire externally. This analysis can help you target your employee training programs to develop the skills you need.

HR can initiate team and company-wide skills gap analyses by holding a meeting with managers to explain the process. It can also be a good idea to hire an external consultant to conduct a skills gap analysis. Hiring an outside evaluator can make the process more objective and will free up staff time to focus on other relevant work.

Step 2: Identify important skills

Some employers say they have difficulty filling jobs because of skill gaps. But others argue that skill gaps are a product of unrealistic expectations. Identify the skills you need by answering two questions:

- What skills do we value as a company?
- What skills do our employees need to do their jobs well now and in the future?

Consider your company's job descriptions, business objectives and company values. Think of the new skills your company might need in coming years. You could also survey team members on what skills they think are missing. Their insights could prove invaluable and involving your employees can help them feel that they're contributing to your company's growth.

Numerical rating scales can be a more practical way to assess skills gaps when you want to aggregate individual scores. You could use a five-point or three-point system. Ensure you have explicitly defined scales. For example, a scale of 1 to 5 could range from poor to excellent, or inexperienced to expert.

Step 3: Measure current skills

To measure skill levels, you could use:

- Surveys and assessments.
- Interviews with employees.
- Feedback from performance reviews.

You can measure skills by creating a skills spreadsheet specific to each individual position.

Sometimes, a skills gap can result from limited experience, especially in the case of new hires. Consider on-the-job coaching as a way to close a skills gap, instead of formal training. An employee with the scores listed above probably doesn't need training in Customer Relationship Management (CRM) software. But, they do have negotiation and Excel skills gaps. Negotiation skills are marked as more important than Excel, so employee training and development should begin there.

Step 4: Act on the data

There are two ways to fill skills gaps: training and hiring. Decide which approach (or combination) works best for each skill gap.

Train for skill gaps

More than half of companies train and develop their staff to fill open positions. Offer training for employees in skills you'd like to strengthen, for example using SAP or Excel. The right training can help you close gaps between current and desired skill levels.

You can use professional training firms to arrange workshops, training sessions and seminars for your staff. Along with formal training, you can also offer:

- Subscriptions, online courses and educational material.
- Voluntary employee mentorship programs.
- Opportunities to attend events and conferences.
- Opportunities to obtain certifications like Project Management Professionals (PMP) or Professional Certified Marketer (PCM).

Hire for skill gaps

If your skills gaps are too wide to minimize with training, consider hiring to bring new knowledge and skills into your company. You could:

Modify your hiring process to screen for skills your company needs. For example, you can add skills assessments (like writing samples) and numerical reasoning tests.

Use structured interviews to reduce biases and ensure your criteria for choosing a new hire are strictly job-related.

Source passive candidates. Often, candidates who have the skills you need aren't looking for a job. Use effective sourcing techniques (like recruiting on Twitter and sourcing using Boolean logic) to find and contact promising candidates.

Conducting a skills gap analysis can be time-consuming. But the results are worth it. Knowing which skills you need to grow as a business will help you hire – and retain – the right people.

Identify and describe project roles, responsibilities and reporting requirements for human resources.

Teams that lack focus or direction can quickly develop poor dynamics, as people struggle to understand their role in the group.

Break Down Barriers

Use team-building exercises to help everyone get to know one another, particularly when new members join the group. These exercises ease new colleagues into the group gently, and also help to combat the "black sheep effect," which happens when group members turn against people they consider different.

Focus on Communication

Open communication is central to good team dynamics, so make sure that everyone is communicating clearly and avoid any ambiguity and ensure that everyone has the same information.





Pay Attention

Watch out for the warning signs of poor group dynamics. Pay particular attention to frequent unanimous decisions, as these can be a sign of groupthink, bullying, or free riding. If there are frequent unanimous decisions in your group, consider exploring new ways to encourage people to discuss their views, or to share them anonymously.

Practical Activity # 3

Role-play activity for human resource planning for a project

Manage Human Resources	
Module: 6	Learning Unit: 3-4 Monitor Human Resource Management Contribute to evaluate human resource practices
	Practical Description: Perform a role-play activity where human resources are being planned for a project
Time:	13 Hours
Equipment	n/a
Tools	n/a
PPE	n/a
Materials	n/a
Key Point	Meeting agenda must be carefully defined
Learning Outcome:	<ul style="list-style-type: none"> • Monitor work of project personnel as per assignment • Review skill levels against allocated tasks • Recommend solutions, where required • Advise others within delegated authority when assigned responsibilities are not met by project personnel • Undertake work in a multi-disciplinary environment according to established human resource management practices • Resolve conflict within delegated authority according to agreed dispute-resolution processes • Assist in offering human resource development opportunities to individuals with skill gaps
Precautions:	Meeting times must be strictly followed
Instructions	Illustrations

<p>1. Analyze project details and deliverables</p>																									
<p>2. Make a list of employees and human resource availability</p>	<table border="1"> <thead> <tr> <th>Employee</th> <th>Type</th> </tr> </thead> <tbody> <tr><td>Arnold Wendy</td><td>Permanent</td></tr> <tr><td>Bergman Tom</td><td>Permanent</td></tr> <tr><td>Jacobs William</td><td>Casual</td></tr> <tr><td>Mason Anthony</td><td>Casual</td></tr> <tr><td>Milward Simon</td><td>Permanent</td></tr> <tr><td>Nguyen Stephen</td><td>Casual</td></tr> <tr><td>Norman Winston</td><td>Casual</td></tr> <tr><td>Ngo Jason</td><td>Permanent</td></tr> <tr><td>Olivera Anthony</td><td>Permanent</td></tr> <tr><td>Telavera Gordon</td><td>Permanent</td></tr> <tr><td>Watson Edward</td><td>Casual</td></tr> </tbody> </table>	Employee	Type	Arnold Wendy	Permanent	Bergman Tom	Permanent	Jacobs William	Casual	Mason Anthony	Casual	Milward Simon	Permanent	Nguyen Stephen	Casual	Norman Winston	Casual	Ngo Jason	Permanent	Olivera Anthony	Permanent	Telavera Gordon	Permanent	Watson Edward	Casual
Employee	Type																								
Arnold Wendy	Permanent																								
Bergman Tom	Permanent																								
Jacobs William	Casual																								
Mason Anthony	Casual																								
Milward Simon	Permanent																								
Nguyen Stephen	Casual																								
Norman Winston	Casual																								
Ngo Jason	Permanent																								
Olivera Anthony	Permanent																								
Telavera Gordon	Permanent																								
Watson Edward	Casual																								
<p>3. Make a list of tentative job and workstation placement</p>																									
<p>4. Consult supervisors and operators for the best possible solutions</p>																									
<p>5. Finalize plan</p>																									
<p>6. Share plan with team members</p>																									

7. Put the plan in writing



Summary of the Module

In the Module of Manage Human Resources the following topics have been covered.

- Determine human resource requirements
- Establish productive team relationships
- Monitor Human Resource Management
- Contribute to evaluate human resource practices.

In the above mentioned topics some critical areas also briefed like

Identify alternative project personnel engagement options

- Acquire Project Team
- Develop Project Team
- Manage Project Team

Develop Human Resource Plan

Explain job design principles and work breakdown structures

- Why use a Work Breakdown Structure?
- Work Breakdown Structure Guidelines
- Tools to Create a Work Breakdown Structure

List methods for skill gap analysis

- Step 1: Plan
- Step 2: Identify important skills
- Step 3: Measure current skills
- Step 4: Act on the data

Identify and describe project roles, responsibilities and reporting requirements for human resources.

- Break Down Barriers
- Focus on Communication
- Pay Attention

Frequently Asked Questions (FAQs)

Question	Answer
1. Is project human resources management different from regular human resource management?	Yes. For project management, human resources can be very different since teams are re-defined in every project
2. Does acquisition of human resources lead to quarrels between organizations?	Human resource acquisition can lead to problems if it is not consensual.
3. When do we all have to do skill gap analysis?	Skill gap analysis is an annual or project based exercise which can be carried out on need basis.
4. How do work breakdown structures help team relationship?	When proper work breakdown structures are defined, there is no shared responsibility for deliverables and hence there is lower chance of conflict to arise.
5. How to breakdown deliverables? Function-wise or Physical location-wise?	Work breakdown is done as per project requirement.
6. What style of communication should we adapt?	Communication style should be as per need.
7. What if we do not take feedback after making a plan?	Without review, a mistake can remain in the plan with correction.
8. Why do leaders require fewer skills than workers?	Leaders do not possess operational skills but they have interpersonal and management skill.

Self-Assessment

(MCQs)

Please mark the correct one from the given options. You can check your answer with the Answer Key at the end of this module

- Q 1. What part of the business plan includes roles and responsibility?
- Financial plan
 - Human resource plan
 - Marketing plan
 - Sales plan
- Q 2. What is staff acquisition?
- Buying material for staff
 - Creating workspace
 - Buying computer
 - Identifying specific human resources required and hiring accordingly
- Q 3. What is the process of tracking team member performance, providing feedback, resolving issues, and managing changes to optimize project performance?
- Manage project team
 - Develop project team
 - Acquire project team
 - None of the above
- Q 4. What are the methods and procedures that are designed to protect team members from the potential safety hazards?
- Finance
 - Safety
 - Operation
 - Marketing
- Q 5. What is WBS?
- Work Breakdown Structure
 - Welding Breaking Structure
 - Warm Breaking structure
 - All of the above
- Q 6. What is the difference between skills that employees want or need?
- Funds gap
 - Employee gap
 - Skill gap
 - Operation gap
- Q 7. Open communication is central to good team dynamics
- True
 - False

- Q 8. Events and conferences can contribute to employee training
- True
 - False
- Q 9. What is HR?
- Hire resource
 - Human rectification
 - Human resources
 - None of the above
- Q 10. _____ is an important step in Human Resource meetings?
- Fight
 - Feedback
 - Food
 - Entertainment

Answer Key

MCQ No.	Correct Answer
1	B
2	D
3	C
4	B
5	A
6	C
7	A
8	A
9	C
10	B

POST PRESS OPERATIONS (Publishing)

Learner Guide

National Vocational
Certificate Level 5

Version 1 - December 2019

Module-7

Module 7: - Manage Personal Finance

Learning Unit:

After completion of this module the learner will be able to:

LU1: Develop a personal budget

LU2: Develop long term personal budget

LU3: Identify ways to maximize future finances

Learning Unit – 1, 2 & 3:

Develop a personal budget

Develop long term personal budget

Identify ways to maximize future finances

Overview: The purpose of this learning unit is to inform the learner to develop, implement and monitor a personal budget in order to plan regular savings and manage debt effectively.

Explain the abilities to plan and organize to keep records and monitor a personal budget

A monthly budget is an estimate, but your goal should be to make as educated an estimate as possible. To do this, you will want to collect a month's worth of pay stubs, bills, and bank statements, if possible.

INCOME

Assuming you are budgeting for an upcoming calendar month, start by looking at your previous month's take-home pay. If you are paid monthly or semi-monthly, this will be easy. If you are paid every other week, multiply your paycheck by 2.166 to determine your monthly pay. Paid weekly? Multiply your check amounts by 4.333.

Budgeting is a bit trickier if your main source of monthly income varies (if you work variable hours or earn tips), you can average several months of income or estimate based upon experience. But be conservative. In a month's time you want to have spent less than you planned for in your budget—a difficult goal when you don't bank as much cash as you thought.

You also want to take other income sources into account.

Do you work more than one job? Will you get a bonus next month? Do you pick up odd gigs or sell old stuff from time to time? Do you have any investments paying dividends?

Create entries in your monthly budget for these additional income sources and create a line for your total monthly income. This is the amount you have to spend for the month and the basis for your "spending plan". You cannot spend more than this in any one month. If you anticipate unusually large expenses next month for which you have money saved (a vacation, for example), consider including the savings you will use to pay for the expense as income. This will allow you to see a more typical monthly spending plan despite the inclusion of a non-monthly expense.

Outline numeracy skills to compare income and expenditure

For your monthly budget to work, your expense projections need to be as accurate as possible. Some expenses, like your rent, car payment, and insurance bill, are simple. From there, it gets trickier.

Chances are your utility bills fluctuate from month to month and how much you spend on groceries, dining out, and clothing may vary drastically. Here's where having a few bills and bank statements will be useful so you can average several months' worth of data.

Place each expense on a line and write down the amount next to it. You may find it useful to create categories of expenses like:

- "Transportation"
- "Household"
- "Food"
- "Entertainment"
- "Debt"

Consider expenses that may not be monthly, such as clothing or car maintenance. You should still budget for these items. If you allocate money every month for these things, that money will be available when you do need it.

Describe abilities to set and review goals

Tracking and estimating your monthly expenses will be harder, but not impossible, if you frequently pay in cash. While cash is a good way to moderate your spending, you need to be diligent about collecting receipts if you want to know where your money went. A new benefit of credit and debit cards now that you can use them virtually everywhere, even for micro payments of just a few dollars, is at the end of the month you get a statement with all of your monthly expenses on one page. If you're struggling with credit card debt, definitely stick with debit cards or cash. But if you can learn to use a credit card responsibly and pay it off in full each month, I actually think a good credit card can make budgeting easier.

Explain basic financial management and record keeping enabling development and management of a personal budget

When you have a complete list of your monthly expenses, add them up and subtract the sum from your monthly income. You should have a positive number. No? Uh-oh. If you have been spending according to this budget, you are going into debt. You will need to find out why your expenses exceed your income and find ways to cut your expenses – fast! Look at your list of expenses and separate discretionary spending. This includes entertainment, travel, gifts, and all dining (including lunches!) Most people can cut their monthly expenses significantly by learning to give up small daily expenditures like coffee or snacks.

If your budgeted expenses fall below your income, congratulations! You are successfully living below your means. The question, now, is how to use your extra money. Follow our six steps to financial stability to help you prioritize your money goals.





Describe benefits of financial goal setting and personal budgeting to enable effective management of personal finances

If you ever want to build wealth and stay out of debt, you have to spend less than you earn. And a budget can ensure that you do that. Still, rigidly tracking every dime you spend is like counting calories — it sounds good in theory, but most of us fail to keep up with it.

Practical Activity # 1

Prepare a monthly financial budget

Manage Personal Finance	
Module: 7	Learning Unit: 1-3 Develop a personal budget Develop long term personal budget Identify ways to maximize future finances
	Practical Description: Prepare a monthly budget highlighting income and expenses
Time:	26 Hours
Equipment	n/a
Tools	n/a
PPE	n/a
Materials	n/a
Key Point	It is imperative that there is a budget surplus otherwise bankruptcy is eminent
Learning Outcome:	<ul style="list-style-type: none"> • Calculate current living expenses using available information to prepare a personal budget. • Keep a record of all income and expenses for a short period of time to help estimate ongoing expenses. • Subtract total expenses from total income to determine a surplus or deficit budget for the specified period. • Find reasons for a deficit budget and ways to reduce expenditure identified. • Identify ways to increase income • Analyze income and expenditure and set long term personal financial goals. • Develop a long-term budget based on the outcomes of short-term budgeting. • Identify obstacles that might affect the business • Formulate a regular savings plan based on budget • Determine sources to maximize personal income, • Get further education or training to maintain or improve future

	<p>income.</p> <ul style="list-style-type: none"> Identify the need for debt to finance living and other expenses, Determine the appropriate levels of debt and repayment.
	<ul style="list-style-type: none"> Consolidate existing debt, where possible, to minimize interest costs and fees. Seek professional money management services.
Precautions:	Collect information diligently to avoid miscalculation
Instructions	Illustration
1. Set savings goal	
2. Collect data from income sources note down all after tax incomes	
3. Collect data from all expense sources	
4. Analyze data carefully, keeping in mind net and gross payments	
5. Subtract the total expenses from total income to get the savings	
6. Determine if the savings are as per planned	

7. Implement budgetary changes to increase savings



Summary of the Module

In the Module of Manage Personal finance the following topics have been covered.

- Develop a personal budget
- Develop long term personal budget
- Identify ways to maximize future finances.

In the above mentioned topics some critical areas also briefed like:

- Abilities to plan and organize to keep records and monitor a personal budget
- Outline numeracy skills to compare income and expenditure
- Describe abilities to set and review goals
- Basic financial management and record keeping enabling development and management of a personal budget
- Benefits of financial goal setting and personal budgeting to enable effective management of personal finances

Frequently Asked Questions (FAQs)

Question	Answer
1. Why is it my job as a supervisor to manage finances?	As a supervisor, managing finances is not the primary function but it is a function that you should be aware of.
2. What is the difference between numeracy and math?	Numeracy is very practical and you'll be using your skills a lot once you've got the hang of them. Mathematics is more broad and sometimes more theoretical.
3. What if we do not have a financial goal?	Only non-profits do not have financial goals but even they look to finance their activities by one source or the other.
4. Is mobile an expense or investment?	Mobile phone is used in work every day and is a great tool to keep in touch with customers. A good phone that helps you deal with customers better is an investment.

Self-Assessment

(MCQs)

Please mark the correct one from the given options. You can check your answer with the Answer Key at the end of this module

Q 1. Utility bills vary from month to month

- a. True
- b. False

Q 2. Rent varies from month to month

- a. True
- b. False

Q 3. A good way of tracking expenses is:

- a. Debt collection
- b. Sleep tracking
- c. Collecting receipts
- d. Running regularly

Q 4. Subtracting your expenses from your income should give you:

- a. A positive number
- b. Tax rebate
- c. Award of achievement
- d. A negative number

Q 5. What is a tool to ensure building wealth and staying out of debt?

- a. Wrench
- b. Budget
- c. Operation
- d. Marketing

Q 6. What is entertainment is categorized as in a budget?

- a. Asset
- b. Debt
- c. Income
- d. Expense

Q 7. What are utilities is categorized as in a budget?

- a. Asset
- b. Debt
- c. Income
- d. Expense

Q 8. Entertainment, travel, gifts and dining are:

- a. Discretionary expenses
- b. Important expense
- c. Essential expense
- d. Assets

Q 9. What does '*living below your means*' mean?

- a. Expense is more than income
- b. Assets are more than expense
- c. Debt is more than assets
- d. Expense is less than income

Q 10. Tracking expenses is easy

- a. True
- b. False

Answer Key

MCQ No.	Correct Answer
1	A
2	B
3	C
4	A
5	B
6	D
7	D
8	A
9	D
10	A

POST PRESS OPERATIONS (Publishing)

Learner Guide

National Vocational
Certificate Level 5

Version 1 - December 2019

Module-8

Module 8: - Solve Problems pertaining to health and safety

Learning Unit:

After completion of this module the learner will be able to:

LU1: Identify a problem

LU2: Determine strategies for a required solution

LU3: Coordinate support services

LU4: Restore order provide leadership.

LU5: Direction to the work group.

Learning Unit - 1:

Identify a problem

Overview: The purpose of this learning unit is to inform the learner to identify a problem to find, understand and solve the root cause.

Explain organization's policies, guidelines and procedures

Policies and procedures go hand-in-hand but are not interchangeable.

A **policy** is a set of general guidelines that outline the organization's plan for tackling an issue. Policies communicate the connection between the organization's vision and values and its day-to-day operations.

A **procedure** explains a specific action plan for carrying out a policy. Procedures tells employees how to deal with a situation and when.

Using policies and procedures together gives employees a well-rounded view of their workplace. They know the type of culture that the organization is striving for, what behavior is expected of them and how to achieve both of these.

The Importance of Policies and Procedures

Developing formal policies and procedures can make it run much more smoothly and efficiently. They communicate the values and vision of the organization, ensuring employees understand exactly what is expected of them in certain situations.

Because both individual and team responsibilities are clearly documented, there is no need for trial-and-error or micromanaging. Upon reading the workplace policies and procedures, employees should clearly understand how to approach their jobs.

Formal policies and procedures save time and stress when handling HR issues. The absence of written policies results in unnecessary time and effort spent trying to agree on a course of action. With strict guidelines already in place, employees simply have to follow the procedures and managers just have to enforce the policies.

Implementing these documents also improves the way an organization looks from the outside. Formal policies and procedures help to ensure your company complies with relevant regulations. They also demonstrate that organizations are efficient, professional and stable. This can lead to stronger business relationships and a better public reputation.

Identify What Is to Be Protected

If you remember that computers are the tools for processing the company's intellectual property, that the disks are for storing that property, and that the networks are for allowing that information to flow through the various business processes, you are well on your way to writing coherent, enforceable security policies.

The following is an example of what can be inventoried:

- Hardware
- Software
- Network equipment
- Diagnostic equipment
- Documentation
- Information assets
- Preprinted forms
- Human resource assets

Identify from Whom It Is Being Protected

Defining access is an exercise in understanding how each system and network component is accessed. Your network might have a system to support network-based authentication and another supporting intranet-like services, but are all the systems accessed like this? How is data accessed amongst systems? By understanding how information resources are accessed, you should be able to identify on whom your policies should concentrate. Some considerations for data access are

- Authorized and unauthorized access to resources and information
- Unintended or unauthorized disclosure of information
- Enforcement procedures
- Bugs and user errors

Setting and Implementing Procedures

The last step before implementation is creating the procedures. Procedures describe exactly how to use the standards and guide- lines to implement the countermeasures that support the policy. These procedures can be used to describe everything from the configuration of operating systems, databases, and network hardware to how to add new users, systems, and software. As was illustrated in Figure 3.4, procedures should be the last part of creating an information security program.

Procedures are written to support the implementation of the policies. Because policies change between organizations, defining which procedures must be written is impossible. For example, if your organization does not perform software development, procedures for testing and quality assurance are unnecessary. However, some types of procedures might be common amongst networked systems, including

Auditing—These procedures can include what to audit, how to maintain audit logs, and the goals of what is being audited.

Administrative—These procedures can be used to have a separation of duties among the people charged with operating and monitoring the systems. These procedures are where you can show that database administrators should not be watching the firewall logs.

Access control—These procedures are an extension of administrative procedures that tell administrators how to configure authentication and other access control features of the various components.

Configuration—These procedures cover the firewalls, routers, switches, and operating systems.



Incident response—These procedures cover everything from detection to how to respond to the incident. These procedures should discuss how to involve management in the response as well as when to involve law enforcement.

Physical and environmental—These procedures cover not only the air conditioning and other environmental controls in rooms where servers and other equipment are stored, but also the shielding of Ethernet cables to prevent them from being tapped.

Practical Activity # 1

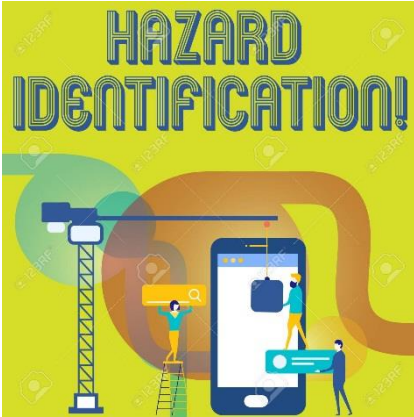
Identify a problem in workplace

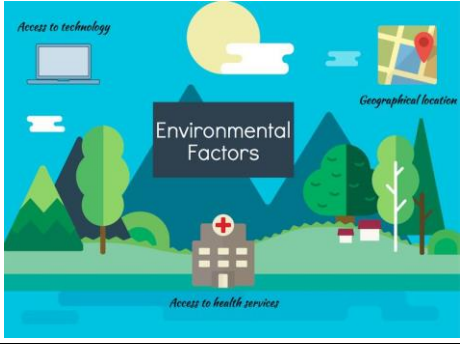
Module: 8	Solve Problems pertaining to health and safety	
	Learning Unit: 1	Identify a problem
	Practical Description:	Make a scenario based safety plan
Time:	05 Hours	
Equipment	n/a	
Tools	n/a	
PPE	n/a	
Materials	n/a	
Key Point	Distinguish between problems and symptoms	
Learning Outcome:	<ul style="list-style-type: none"> • Probe the problem to find the root cause. • Follow logic steps in understanding root cause • Analyze potential solutions. • Take initiative which help to solve problems 	
Precautions:	Operators must be consulted before assigning responsibilities	
Instructions		Illustrations
<p>1. Identify what kind of hazards does the workstation entails</p>		

<p>2. Sketch out the worst case scenario where all the environmental factors have gone wrong</p>	 An illustration titled "Environmental Factors" showing a landscape with mountains, trees, and a house with a red cross. It includes icons for "Access to technology" (a laptop), "Geographical location" (a map), and "Access to health services" (a house with a cross).
<p>3. Make policy changes to reduce the number of safety based instances</p>	 A signpost with a circular arrow icon above a rectangular sign that reads "POLICY CHANGES".

Learning Unit - 2:

Determine strategies for a required solution

Overview: The purpose of this learning unit is to inform the learner to determine strategies for a required solution.

Describe teamwork principles and strategies

Five Basic Elements of Effective Teams



Effective teams share five key characteristics:

Positive Interdependence	Members believe they are linked together; they cannot succeed unless the other members of the group succeed (and vice versa). They sink or swim together.
Individual Accountability	The performance of each individual member is assessed and the results given back to the group and the individual
Group Processing	At the end of its working period, the group processes its functioning by answering two questions: <ul style="list-style-type: none"> • What did each member do that was helpful for the group? • What can each member do to make the group work better?
Skills in Communication	Necessary for effective group functioning. Members must have – and use – the needed leadership, decision-making, trust-building, communication, and conflict-management skills.
Promote Interaction	Members help, assist, encourage, and support each other's efforts to learn.

The eight principles of successful interdisciplinary teamwork with proposed team commitments are:

1. The team should have explicitly stated team goals.



- Each team member will be able to state the team's purpose and goals.

- All team members will have the opportunity to participate in annual strategic planning process.
2. The patient and family are at the center of all team activities and are active team members
- Patient/family health care goals will be explicitly discussed at all individual care plan conferences.
 - Patients/family members/caregivers may be invited to participate in care planning.
 - Care plans are discussed with patients/families
3. Professional roles must be clearly defined and understood.
- All team members will have a role definition and this will be shared with team members.
 - Team members will understand their role in individual care plans.
 - Focused discussions will be held among team members where roles overlap.
4. All team members should contribute to team function through constructive individual behaviors, including leadership.
- Team members will understand their own and other team member's communication styles.
 - All team members will understand the indications for using specific team behaviors
 - All team members will participate as facilitators for team meetings.
5. There must be effective team communication across all work settings.
- All team members will be trained in effective clinician-patient communication.
 - Team members will understand their personal communication style under stress.
6. The team must have tools or strategies for the effective management of conflict.
- All team members will be trained in conflict management.
7. The team should have explicit rules about participation and decision making.
- Decisions will be made by "consensus" whenever possible.
 - Team members will identify when a vote might be needed.
 - When decisions are being discussed, all team members will have the opportunity to provide their opinion.
 - Ground rules will be established.
 - Team members will be knowledgeable of other group process techniques to ensure balanced participation.

Practical Activity # 2

Make scenario based safety action plan

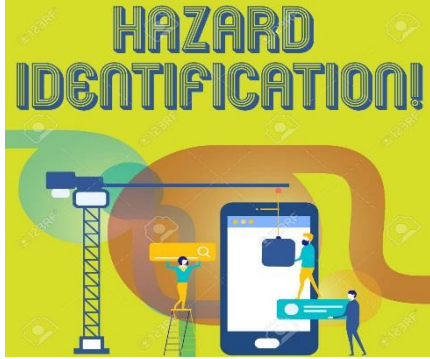
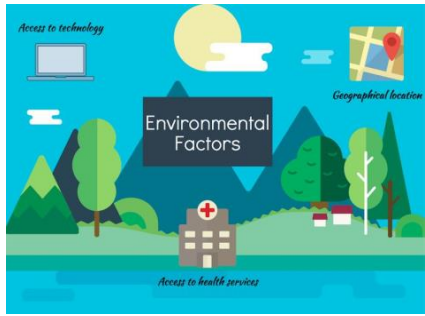
Solve Problems pertaining to health and safety		
Module: 8	Learning Unit: 2	Determine strategies for a required solution
	Practical Description:	Make a scenario based safety action plan for a workstation
Time:	05 Hours	
Equipment	n/a	
Tools	n/a	
PPE	n/a	
Materials	n/a	
Key Point	Employees must be well trained for emergency situations	
Learning Outcome:	<ul style="list-style-type: none"> • Analyze all aspects of the incident for degree of <ul style="list-style-type: none"> ○ Hazard ○ Priorities ○ Optional outcomes ○ Appropriate strategies • Find strategies for the needed solution of the incident • Identify priorities on the incident sought from a range of sources • Asses objectives with available resources • Assess priorities with available resources • Apply a range of communication techniques to maintain contact with the key people • Resolve the conflict 	
Precautions:	Human life is the most important resource to protect in an emergency situation	
Instructions	Illustrations	

<p>1. Identify what kind of hazards does the workstation entails</p>	
<p>2. Sketch out the worst case scenario where all the environmental factors have gone wrong</p>	
<p>3. Find out what safety equipment can save operator from the hazards identified</p>	
<p>4. Identify emergency situation roles</p>	
<p>5. Identify assembly points, emergency exits and evacuation plans in case of an incident</p>	

Learning Unit - 3:

Coordinate support services

Overview: The purpose of this learning unit is to inform the learner to assess the need for support services, negotiate the resources and assign responsibilities according to expertise.

Organization's management and accountability systems

Accountability systems serve to prompt and encourage people to keep their promises to each other.

Accountability is no more a one-man job than is quality. If accountability lies only with the individual it will rise and fall with changes in personnel and positions. Accountability starts with a broad based effort to set and measure performance standards across an organization's divisions and functions.

Accountability and reliability go hand in hand. Both rely on effective work management. In a production environment, for example, the plant manager holds people accountable for creating good systems, beginning with senior staff.

What are the elements of accountability?

- A system for budget management that includes the format and timing of reports, the frequency and content of meetings, and the efficacy of actions that arise from budget review.
- A system of problem solving that identifies problems early, prioritizes them, gets the right people involved, generates a set of possible solutions and tracks the success of the solution once it is implemented.
- A system of communication that gets real time information to the people who can best use it to affect their performance.
- Systems of reporting relationships and performance measurement that promote the stated goals of the organization.
- A system of internal benchmarking that learns from other areas of the company -- and gladly helps them learn from you.

Systems overlap and reinforce each other. Effective accountability programs draw from the budget, problem solving and communication systems. They emphasize performance measurement and review, team-based organizational structures and goals and positive discipline. Ideally, the accountability system is built by those who are enmeshed in it. An organization's leaders must set out to deliberately, intelligently and quickly lead the building of these systems.

Accountability is expressed as a system of interlocking elements. These elements are the building blocks of how we both measure and communicate performance expectations and results as individuals, as work groups, as entire organizations. The list of accountability elements includes:

- Customer Satisfaction

- Weekly Staff Meetings
- Action Item Lists
- Long-Term Work Scheduling (3 Week)
- Process Conferences
- MBWA
- Formal Problem-Solving Process
- Defined Work Processes
- Financial Goals, High Level KPIs
- Operational Goals
- Work Management KPIs
- Unit/Line Reliability Teams
- Clear Value System with rewards and consequences for behavior
- Daily Schedule Compliance Meetings (After Action Analysis)
- Roles, Responsibilities and Relationships (Relationships can mean Organizational Structure)

To be effectively utilized, each element must be clearly defined in terms of how the organization will use it and how it fits into the overall system of accountability. The entire system of accountability must support and reinforce the business mission of the organization. This means that each accountability element must support and reinforce the entire business mission.

How should the process begin? First, senior staff must decide what the goals of the organization are, then codify these as expected outcomes. Once such goals have been established, the plant decides what measures it can use to best monitor its performance. Corporate key performance indicators should be only the starting point for these decisions. From there, people should be given a clear set of expectations about system fundamentals -- including a sense of urgency -- and then turned loose to create systems that will deliver great performance.

To help groups and individuals work in ways that promote the desired outcomes, measures are developed and communicated appropriately to give feedback on how well or poorly that work is accomplishing the goals. Because work in organizations exists in a complicated context of people, processes and equipment, there is rarely a direct, linear cause and effect type of measure that is useful in gauging performance. Accountability, then, is the means of ensuring that, despite the complexity of the work and the context in which it exists, individuals, groups and, ultimately, the organization as a whole will understand their part in accomplishing goals.

Practical Activity # 3

Develop an emergency plan

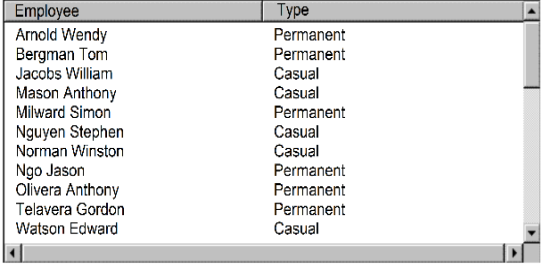
Solve Problems pertaining to health and safety																									
Module: 8	Learning Unit: 3 Coordinate support services																								
	Practical Description: Make an emergency plan with defined roles for each personnel																								
Time:	05 Hours																								
Equipment	n/a																								
Tools	n/a																								
PPE	n/a																								
Materials	n/a																								
Key Point	Emergency situations should be well rehearsed to reduce panic																								
Learning Outcome:	<ul style="list-style-type: none"> • Assess the need for support services in terms of the determined strategies and priorities • Negotiate the resources of support services according to established procedures • Assign responsibilities according to expertise 																								
Precautions:	All safety roles must be well defined to avoid confusion																								
Instructions	Illustrations																								
<p>1. Create a list of employees which can think fast on their feet</p>	 <table border="1" style="width: 100%; border-collapse: collapse;"> <thead> <tr> <th style="text-align: left;">Employee</th> <th style="text-align: left;">Type</th> </tr> </thead> <tbody> <tr><td>Arnold Wendy</td><td>Permanent</td></tr> <tr><td>Bergman Tom</td><td>Permanent</td></tr> <tr><td>Jacobs William</td><td>Casual</td></tr> <tr><td>Mason Anthony</td><td>Casual</td></tr> <tr><td>Milward Simon</td><td>Permanent</td></tr> <tr><td>Nguyen Stephen</td><td>Casual</td></tr> <tr><td>Norman Winston</td><td>Casual</td></tr> <tr><td>Ngo Jason</td><td>Permanent</td></tr> <tr><td>Olivera Anthony</td><td>Permanent</td></tr> <tr><td>Telavera Gordon</td><td>Permanent</td></tr> <tr><td>Watson Edward</td><td>Casual</td></tr> </tbody> </table>	Employee	Type	Arnold Wendy	Permanent	Bergman Tom	Permanent	Jacobs William	Casual	Mason Anthony	Casual	Milward Simon	Permanent	Nguyen Stephen	Casual	Norman Winston	Casual	Ngo Jason	Permanent	Olivera Anthony	Permanent	Telavera Gordon	Permanent	Watson Edward	Casual
Employee	Type																								
Arnold Wendy	Permanent																								
Bergman Tom	Permanent																								
Jacobs William	Casual																								
Mason Anthony	Casual																								
Milward Simon	Permanent																								
Nguyen Stephen	Casual																								
Norman Winston	Casual																								
Ngo Jason	Permanent																								
Olivera Anthony	Permanent																								
Telavera Gordon	Permanent																								
Watson Edward	Casual																								

2. Assign roles to each employee according to their location in the workplace



3. Ensure all employees are well trained for any emergency situation



Learning Unit – 4 & 5:

Restore order

Provide leadership direction to the work group

Overview: The purpose of this learning unit is to inform the learner to observe, take proactive action, and communicate accurate reports of the incident.

Principles of Effective Communication

The communication should always be consistent with the objectives, policies and programmes of the enterprise. Communication is effective when the workers are receptive to it and are able to give relevant feedback.

The chief purpose of communication is the exchange of ideas among various people working in the organization. The process of communication should be helpful in an effective exchange of information. The remedies for the removal of barriers in communication also point towards effective communication.

An effective communication system is based on the following principles:

(1) Principle of Clarity in Ideas:

First of all it should be clear in the mind of the sender as to what he wants to say. According to Terry the principle of effective communication is 'first to fully inform oneself.' The clearer the thought the more effective is the communication.

(2) Principle of Appropriate Language:

According to this principle, the communication should always be in a simple language. Ideas should be clear and be devoid of any doubt. Technical words and words having various meanings should be used to the minimum.

(3) Principle of Attention:

The purpose of communication is that the receiver of information should clearly understand its meaning. It means merely transferring information is not communication and it is important that the receiver should understand it. This is possible only when the receiver takes interest in the message and listens to it attentively.

(4) Principle of Consistency:

According to this principle, communication system should maintain consistency in the objectives of the enterprise, its procedures and processes. It means communication should be in accordance with the policies laid down for it.

(5) Principle of Adequacy:

The information sent to the receiver should be sufficient and complete in every respect. Information more than the need or less than the need is harmful. In the context of

business incomplete information is dangerous. The sufficiency of information depends on the ability of the receiver. If the receiver happens to be capable more information can be given with the help of a few words. On the contrary, in case of a less capable receiver more details are needed.

(6) Principle of Proper Time:

The messages should reach the receiver whenever they are needed. Late messages are meaningless and the utility of communication is ended. Hence, the message should be sent before the actual need keeping in mind the time required for communication.

(7) Principle of Informality:

Formal communication has a prominent place among the channels of communication but informal communication is not less important. There are some problems which cannot be solved with formal communication but informal communication does succeed in solving them. Therefore, informal communication should also be given recognition in the organization.

(8) Principle of Feedback:

It is essential for the sender of the message that he should know about the success of the message. It means that he should see whether the receiver has understood the message or not. Feedback is easily obtained in a face to face communication with the help of the facial reactions of the receiver. In the written communication the sender can get the feedback by using appropriate means.

(9) Principle of Integration:

Communication should be able to introduce all the employees in the enterprise with its objectives so that all the employees move unitedly towards the goal.

(10) Principle of Consultation:

The suggestions of all the persons concerned should be invited while making plans for communication. The obvious benefit of such a move will be that all those who are invited while making plans for communication and taken into confidence will contribute to the success of the communication system. Planning for communication aims at determining as to when, how and through what medium communication is to be done among people working at different levels.

(11) Principle of Flexibility:

Communication system should be able to absorb the changes in the organization. A communication system that cannot absorb changes according to the need becomes meaningless.

(12) Principle of Economy:

Communication system should not be unnecessarily costly. As far as possible unnecessary messages should be reduced to the minimum to make communication economical. No single employee should be burdened with the work of communication.

(13) Principle of Proper Medium:

In order to make communication effective it is necessary not only to have clarity of ideas, consistency and completeness but also to make a proper choice of medium. For example- the managers should make use of oral communication for individual communication and written communication for policy matters.

Effective communication means communication free from barriers. Though ideal communication free from all barriers is seldom achieved, communicators should acquire communication skills and enhance effectiveness of their communication.

Guidelines for use of equipment and technology**Printed Electronics Technologies**

Printed electronics promises lower costs as well as opportunities for innovative functionality, such as mechanical flexibility, that is traditionally more difficult (or impossible) and more expensive with conventional electronics approaches. Thanks to a variety of printed electronics technologies and printing methods, engineers have a variety of options for meeting project requirements and specifications.

Printing Methods

Printing methods include popular approaches such as inkjet printing and screen printing, both of which are well-suited for low-volume and high-precision projects. Printing methods include, but are not limited to:

Inkjet printing – Flexible and versatile with low-effort setup, inkjet printing is suitable for low-viscosity, soluble materials such as organic semiconductors. Flexible circuit

Screen printing – Can produce thick, patterned layers using paste-like materials, making it suitable for producing conducting lines from inorganic materials such as antennas and circuit boards. Screen printing is also a useful method for insulating and passivating layers, particularly when the thickness of a layer is more important than resolution.

Gravure – Formally, this printing method is called Rotogravure, although it's often called Roto or Gravure. The process involves the engraving of an image onto an image carrier. It uses a rotary printing press to engrave images onto a cylinder.

Offset printing – Offset printing is a legacy printing method that offsets, or transfers, an inked image from a plate to rubber sheet and then onto the printing surface.

Flexographic printing – This printing technique makes use of a flexible relief plate. Similar to a letterpress, flexographic printing can be used on any type of substrate, from plastic, to metallic films, to paper.

Aerosol Jet Printing – Also known as M3D (Maskless Mesoscale Materials Deposition), Aerosol Jet Printing begins by atomizing an ink, which produces droplets of one to two micrometers in diameter. These droplets are then delivered to a print head via a gas stream and impinge on the substrate at high velocity. This process enables the printing of conformal patterns on 3D substrates. The ink typically requires a post-treatment to achieve the desired electrical and mechanical properties.

Evaporation printing – Uses a combination of high precision screen printing with material vaporization. Evaporation printing uses techniques such as thermal, e-beam, sputter, and others to deposit materials through a stencil (a high precision shadow mask) registered to the substrate. It allows for the layering of different mask designs using various materials.

Gravure, offset, and flexographic printing methods are more commonly used for high-volume production needs, such as solar cells. Offset and flexographic printing are primarily used for inorganic and organic conductors, while gravure printing is suitable for quality-sensitive layers thanks to its high layer quality as well as for inorganic and organic conductors for applications in which high resolution is required. Gravure printing may be used for organic semiconductors and semiconductor/dielectric-interfaces in transistors.

Code of conduct





A Code of Conduct applies the Code of Ethics to a host of relevant situations. A particular rule in the Code of Ethics might state that all employees will obey the law, a Code of Conduct might list several specific laws relevant to different areas of organizational operations, or industry, that employees need to obey.

The Code of Conduct outlines specific behaviors that are required or prohibited as a condition of ongoing employment. It might forbid sexual harassment, racial intimidation or viewing inappropriate or unauthorized content on company computers. Codes, along with other measures, have helped some companies dig themselves out of scandals, and have helped many companies build a healthier work climate and reputation.

Practical Activity # 4

Role-play an incident follow-up meeting

Solve Problems pertaining to health and safety					
Module: 8	<table border="1"> <tr> <td>Learning Unit: 4-5</td> <td> Restore order Provide leadership direction to the work group </td> </tr> <tr> <td>Practical Description:</td> <td>Perform a role-play for a meeting where an incident in the workplace is being reported</td> </tr> </table>	Learning Unit: 4-5	Restore order Provide leadership direction to the work group	Practical Description:	Perform a role-play for a meeting where an incident in the workplace is being reported
	Learning Unit: 4-5	Restore order Provide leadership direction to the work group			
Practical Description:	Perform a role-play for a meeting where an incident in the workplace is being reported				
Time:	10 Hours				
Equipment	n/a				
Tools	n/a				
PPE	n/a				
Materials	n/a				
Key Point	All incidences should be documented for future references				
Learning Outcome:	<ul style="list-style-type: none"> • Observe that the situation after the incident solution is normalized • Take proactive action to avoid the incident to the possible extent • Communicate accurate reports of the incident and its correction to the authorities • Review the incident • evaluate the incident • Evaluate the organizational response • Report it accurately on time • Link group functions with organizational goals • Participate in decision making routinely to: <ul style="list-style-type: none"> ○ Develop the work of the group ○ Allocate responsibilities where appropriate • Give opportunities to the work group for encouragement • Give opportunities to ensure innovative practices in the work group • Identify conflict • Resolve with minimum disruption to work group function • Empower the work group where necessary • Requirement of the tasks 				

Precautions:	Information provided verbally must be followed up to find negligence	
Instructions		Illustrations
1. Greet all participants and narrate the agenda.		
2. Ask for the employee's physical and mental health		
3. Report the incident and the root cause		
4. Inculcate policies do that negligence is not repeated		

5. Ask for feedback on the new responsibilities



Summary of the Module

In the Module of Solve Problems pertaining to health and safety the following topics have been covered.

- Identify a problem
- Determine strategies for a required solution
- Coordinate support services
- Restore order provide leadership.
- Direction to the work group

In the above mentioned topics some critical areas also briefed like:

Explain organization's policies, guidelines and procedures

- The Importance of Policies and Procedures
- Identify What Is to Be Protected
- Identify from Whom It Is Being Protected
- Setting and Implementing Procedures

Describe teamwork principles and strategies

- Positive Interdependence
- Individual Accountability
- Group Processing
- Skills in Communication
- Promote Interaction

Organization's management and accountability systems

- Elements of accountability

Principles of Effective Communication

1. Principle of Clarity in Ideas
2. Principle of Appropriate Language
3. Principle of Attention
4. Principle of Consistency
5. Principle of Adequacy
6. Principle of Proper Time
7. Principle of Informality
8. Principle of Feedback
9. Principle of Integration
10. Principle of Consultation
11. Principle of Flexibility
12. Principle of Economy
13. Principle of Proper Medium

Guidelines for use of equipment and technology

Frequently Asked Questions (FAQs)

Question	Answer
1. Do safety procedures help or hinder operations?	Having good safety policy can help avoid accidents that can lead to much longer stop times.
2. How can we determine what is to be protected?	Human life is the first thing to protect, then you can prioritize the assets to protect in case of an accident.
3. Should the safety policies be forcefully implemented?	Yes.
4. How can work hazards be highlighted?	By properly labeling hazardous areas.
5. Why is goal setting important?	Goals help motivate teams to work harder
6. If the whole team will participate in decision making will that lead to loss of time?	It is up to the discretion of the leader to decide whom to include in the decision making process. This is done after considering available time and importance of the decision.

Self-Assessment

(MCQs)

Please mark the correct one from the given options. You can check your answer with the Answer Key at the end of this module

- Q 1. Way of protecting individuals' well-being of health is classified as
- safety
 - health
 - adverse situation
 - security
- Q 2. Health and safety performance within an organization is linked to:
- Organizational performance and culture.
 - The skill level of employees.
 - Employee attitudes towards supervisors.
 - industry standards and procedures
- Q 3. Which one of the following is Fire Fighting Equipment:
- Construction Material
 - Computerized Material
 - Fire Extinguisher
 - Drilling Equipment
- Q 4. What is abbreviation of 5S on workplace?
- Sort, Set In Order, Shine, Standardize And Sustain
 - Sales, Services, Spare Parts, Second Hand Exchange And Safety
- Q 5. Following is not the aspect of incident
- Hazard
 - Priorities
 - Optional Outcomes
 - Driving
- Q 6. What is the main hazard identification?
- To minimize the effect of a consequence
 - For better risk management
 - The adverse effect of toxins
 - To reduce probability of occurrence
- Q 7. The _____ process determines exposure to a chemical can increase the incidence of adverse health effect.
- Hazard identification
 - Exposure assessment
 - Toxicity assessment
 - Risk characterization

- Q 8. Hazard is defined as the probability of suffering harm or loss.
- True
 - False
- Q 9. Process which begins when one party perceives that other has frustrated, or is about to frustrate, some concern of his, is known as
- Conflict
 - Risk
 - Uncertainty
 - Poor management
- Q 10. Which one of the following is not a characteristic of a team?
- Lack of knowledge sharing
 - Collective output
 - Individual and collective responsibility
 - Fluid dimension to roles and tasks

Answer Key

MCQ No.	Correct Answer
1	A
2	A
3	C
4	A
5	D
6	C
7	A
8	A
9	A
10	A

POST PRESS OPERATIONS (Publishing)

Learner Guide

National Vocational
Certificate Level 5

Version 1 - December 2019

Module-9

Module 9: - Develop Business Plan

Learning Unit:

After completion of this module the learner will be able to:

LU1: Prepare project management plan

LU2: Develop and evaluate management plan

LU3: Communicate project information

LU4: Contribute to assessing effectiveness of communication

Learning Unit – 1:

Prepare project management plan

Overview: The purpose of this learning unit is to inform the learner to prepare project management plan using evaluation of project, produce document on project, assess resources, produce training plan, consulting with all relevant parties and make appropriate changes.

Components of a project plan

The primary components of a project management plan are:

1. Scope Statement
2. Critical Success Factors
3. Deliverables
4. Work Breakdown Structure
5. Schedule
6. Budget
7. Quality
8. Human Resources Plan
9. Stakeholder List
10. Communication
11. Risk Register
12. Procurement Plan



Project plan participants and information sharing



- Understand the user needs and business processes of their area
- Act as consumer advocate in representing their area
- Communicate project goals, status and progress throughout the project to personnel in their area
- Review and approve project deliverables
- Creates or helps create work products
- Coordinates participation of work groups, individuals and stakeholders
- Provide knowledge and recommendations
- Helps identify and remove project barriers
- Assure quality of products that will meet the project goals and objectives
- Identify risks and issues and help in resolutions

Practical Activity # 1

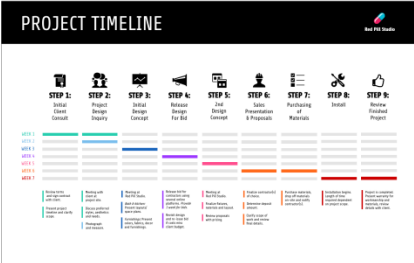
Prepare a plan to complete a project

Develop Business Plan		
Module: 9	Learning Unit: 1	Prepare project management plan
	Practical Description:	Make a plan before starting a project
Time:	06 Hours	
Equipment	n/a	
Tools	n/a	
PPE	n/a	
Materials	n/a	
Key Point	Projects should be prioritized based on organizational requirements	
Learning Outcome:	<ul style="list-style-type: none"> • Evaluate project brief and related documents • Produce document on project tasks and associated timelines, including <ul style="list-style-type: none"> ○ Installation processes ○ Test requirements • Assess resource requirements • Produce document on resource requirements to assist allocation of appropriate resources • Produce training plan assessing training needs and associated timelines for efficient project implementation • Determine budgetary requirements • Discuss roles of all identified parties associated with project to ensure their involvement • Produce project verification document, including <ul style="list-style-type: none"> ○ Monitoring ○ Control processes 	

	<ul style="list-style-type: none"> • Review processes such as quality audits • Consult with all relevant parties prior to finalizing draft Plan • Make changes as appropriate
Precautions:	Project timeline must be strictly followed
Instructions	Illustrations
1. Evaluate project brief and related documents	
2. Make project tasks and associated timelines	
3. Assess resource requirements	
4. Determine budgetary requirements	

<p>5. Discuss roles of all identified parties associated with project to ensure their involvement</p>	
<p>6. Review processes such as quality audits</p>	
<p>7. Consult with all relevant parties prior to finalizing draft plan, make changes as appropriate</p>	

Learning Unit – 2:

Develop and evaluate management plan

Overview: The purpose of this learning unit is to inform the learner to develop and evaluate management plan producing preliminary plan, identifying factors that may impact, consulting with client and develop final plan.

Work health and safety issues that need to be built into a plan

As an employer, manager or coordinator you are required to develop, implement and review an overall system for effectively managing WHS to ensure the safety of your workers.

Some of the activities that make up the WHS management system include:

- Policies and procedures
- WHS planning
- Hazard management
- Induction and ongoing training for all staff
- Consultation with workers and their representatives
- Incident reporting and investigation
- Injury management
- Emergency planning
- Record keeping, monitoring, analysis and review.

The complexity and formality of these activities will depend on the nature and size of your organization.

Policies and procedures

Your WHS policy is a written statement of your commitment to WHS.

The policy should be developed in consultation with workers and include:

- The responsibilities of management and workers (including volunteers and contractors)
- Accountabilities for WHS.

The policy should also:

- Encourage cooperation and consultation between managers and workers
- Outline how WHS will be managed using a planned continuous improvement approach with an emphasis on hazard management
- Outline roles and responsibilities for injury management
- Be available to workers (and understood by them).

Procedures should be developed to outline how the requirements of the policy will be met, so there may be procedures for:

- Hazard management

- Conducting client home assessments
- Manual handling
- Personal security
- Hazardous substances
- Accident reporting and investigation
- Injury management
- Any other areas of concern.

WHS planning

WHS management systems should be continuously improving with managers and workers always seeking to improve outcomes. Strategies for improvement should be included in a WHS plan.



Developing a plan requires you and your workers to:

- Consider where you are now
- Set goals or objectives for where you wish to be
- Priorities goals
- For each goal identify steps or actions needed to achieve it
- For each action, state who is responsible for doing it, the timeframe and date for review of progress
- Review goals and the WHS plan regularly.

Practical Activity # 2

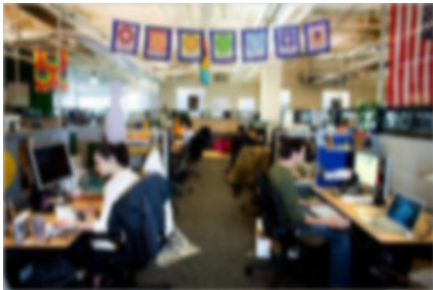
Make scenario based contingency action plan

Develop Business Plan		
Module: 9	Learning Unit: 2	Develop and evaluate management plan
	Practical Description:	Make a scenario based contingency plan for a workstation
Time:	06 Hours	
Equipment	n/a	
Tools	n/a	
PPE	n/a	
Materials	n/a	
Key Point	Recommendations must be taken from the operator to identify more alternatives	
Learning Outcome:	<ul style="list-style-type: none"> • Produce preliminary plan for consultation • Identify factors that may impact on project as per standards • Consult with client to clarify any amendments • Develop final plan with recommendations 	
Precautions:	Do not indulge in nuisance	
Instructions		Illustrations
<ol style="list-style-type: none"> 1. Identify what kind of delays or issues does the workstation entails 		

<p>2. Sketch out the worst case scenario where all the environmental factors have gone wrong</p>	 An illustration titled "Environmental Factors" showing a landscape with mountains, trees, and a building with a red cross. Labels include "Access to technology" (with a laptop icon), "Geographical location" (with a map icon), and "Access to health services" (with a building icon).
<p>3. Find out how the operator can rectify the situation at hand</p>	 A green robot character holding a large wrench and standing next to a gear. The robot has a stylized 'S' on its chest. The word "STARTS" is written vertically on the wrench.
<p>4. Ensure operator has the requisite tools available to deal with the problem at hand</p>	 An illustration of a desk with various office supplies: a laptop, a smartphone, a calculator, a magnifying glass, a notebook, a pen, and a cup of coffee.

Learning Unit – 3 & 4:

Communicate project information

Contribute to assessing effectiveness of communication

Overview: The purpose of this learning unit is to inform the learner to communicate project information and contribute to assessing effectiveness of communication.

Information collection plan

Collection planning. A continuous process that coordinates and integrates the efforts of all collection units.

Information sharing methods

Information sharing describes the exchange of data between various organizations, people and technologies. There are several types of information sharing: Information shared by individuals (such as a video shared on Facebook or YouTube)

Information analyzing methods

Data analysis has two prominent methods: qualitative research and quantitative research. Each method has their own techniques. Interviews and observations are forms of qualitative research, while experiments and surveys are quantitative research

Information privacy

Information privacy is the relationship between the collection and dissemination of data, technology, and public expectation of privacy, legal and political issues surrounding them. It is also known as data privacy or data protection

Types of communication in projects

Various types of communication may be involved in the overall planning and execution of the final project and can include verbal, written, electronic and face-to-face interactions. The flow of information also plays an important role in the success of your project

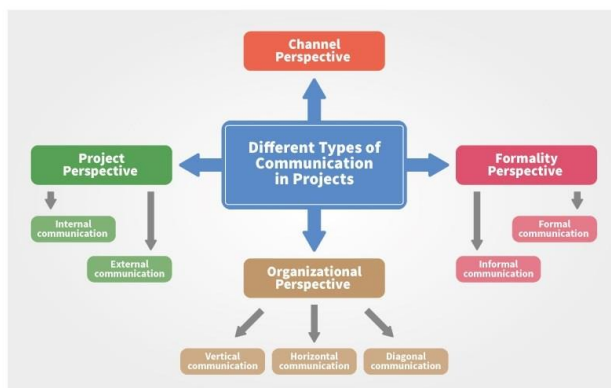

Reporting methods in pre-press

There are two broad categories of reporting methods: those that are written (annual reports, fact sheets, etc.) and those that are oral/visual (PowerPoint presentations, exhibits, news releases, etc.). Regardless of the method, the report should take into account the audience and be both accessible and understandable.



Assessment of communication network

Communications Assessment Guide. The goal of a communications assessment, or audit, is to determine an organization's effectiveness in communicating with internal and external stakeholders. The amount of resources and time required to perform an audit depends primarily on the size and needs of the organization.

Practical Activity # 3

Review project plan

Develop Business Plan	
Module: 9	Learning Unit: 3-4 Communicate project information Contribute to assessing effectiveness of communication
	Practical Description: Analyze and review a developed project plan with customers
Time:	14 Hours
Equipment	n/a
Tools	n/a
PPE	n/a
Materials	n/a
Key Point	Information only pertaining to the project should be shared with customers
Learning Outcome:	<ul style="list-style-type: none"> • Produce and document final plan to include implementation details and training needs • Present plan to client and obtain sign off • Assist in ongoing review of project outcomes to determine effectiveness of communications-management activities • Report communications-management issues and responses to higher project authorities
Precautions:	Customer access to information must be monitored
Instructions	Illustrations
<p>1. All project details must be put together as a project plan which will include responsibilities, deliverables and time lines</p>	

<p>2. The project plan must be shared with customers</p>	
<p>3. Monitoring and evaluation methods must be placed to check the progress and product quality</p>	
<p>4. Customers must be included in the review process if any</p>	

Summary of the Module

In the Module of Develop Business Plan the following topics have been covered.

- Prepare project management plan
- Develop and evaluate management plan
- Communicate project information
- Contribute to assessing effectiveness of communication

In the above mentioned topics some critical areas also briefed like:

Policies and procedures

WHS planning

Information collection plan

Types of communication in projects

Reporting methods in pre-press

Assessment of communication network

Frequently Asked Questions (FAQs)

Question	Answer
1. When do we make a business plan?	After secondary research, business plan is formulated.
2. Is business plan important?	Very. Business plan helps you to answer questions before they occur in implementation.
3. Is project information important?	Yes. Through project management, project deliverables can be managed much efficiently.

Self-Assessment

(MCQs)

Please mark the correct one from the given options. You can check your answer with the Answer Key at the end of this module

Q 1. Why do we need business plan?

- a) Planning of a future business
- b) Planning to study
- c) Planning of preparing document
- d) Planning for traveling

Q 2. What is budget?

- a) Estimate of income and expenditure for a set period of time
- b) Weather forecasts
- c) Production plan
- d) Work schedule

Q 3. Explain what is marketing plan?

- a) A report that outlines the marketing strategy.
- b) A financial report
- c) An audit report
- d) A quality report

Q 4. Budget is important in Business to control the finances of a business?

- a) True
- b) False

Q 5. The decision to request an increase the resources for a project is the responsibility of the:

- a) Functional manager
- b) Project manager
- c) Director of project management
- d) Customer

Q 6. Which of the following is the most efficient means of product quality inspection?

- a) Acceptance sampling
- b) 100% inspection
- c) Variable sampling
- d) a and c

Q 7. What is WHS?

- a) Work Health and Safety

- b) Work Harm and Solution
- c) Weak Health and Safety
- d) None of the above

Q 8. Where in a project plan does emergency planning comes?

- a) Financial plan
- b) Equipment and tools
- c) Work Health and Safety
- d) Marketing plan

Q 9. What is a continuous process that coordinates and integrates the efforts of all information collection units?

- a) Information sending plan
- b) Information collection plan
- c) Duty plan
- d) Shift plan

Q 10. Written and oral are the two types of _____?

- a) Computers
- b) Tools
- c) Solutions
- d) Reporting

Answer Key

MCQ No.	Correct Answer
1	A
2	A
3	A
4	A
5	B
6	C
7	A
8	C
9	B
10	D

POST PRESS OPERATIONS (Publishing)

Learner Guide

National Vocational
Certificate Level 5

Version 1 - December 2019

Module-10

Module 10: - Apply Information and Communication Skills

Learning Unit:

After completion of this module the learner will be able to:

- LU1: Contribute to communications planning
- LU2: Conduct information-management activities
- LU3: Communicate project information
- LU4: Contribute to assessing effectiveness of communication

Learning Unit – 1:

Contribute to communications planning

Overview: The purpose of this learning unit is to inform the learner to contribute to communication planning.

Summarize models and methods of communications management in context of project life cycle and other project management functions

To communicate effectively, project managers must have a good understanding of the communications process.

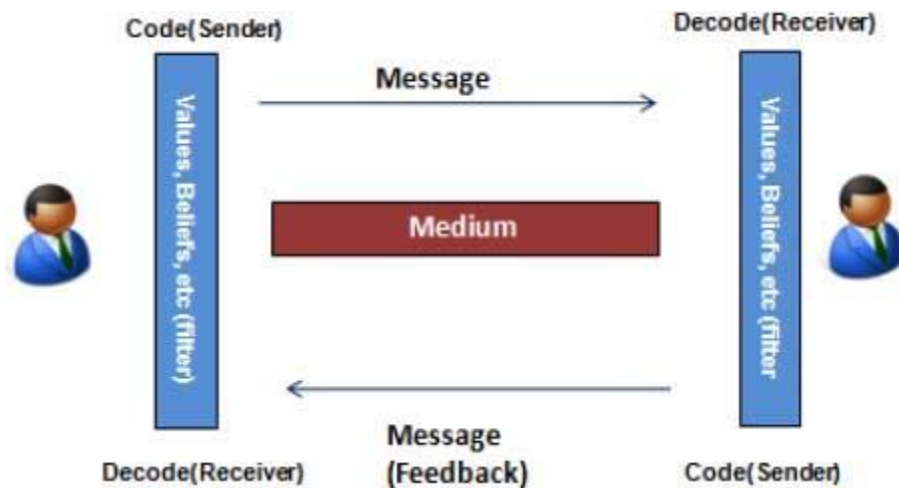

Based on stakeholder analysis, the project manager and the project team can determine the communications that are needed. There is no advantage of supplying stakeholders with information that isn't needed or desired, and the time spent creating and delivering such information is a waste of resources.

A communications management plan can organize and document the process, types, and expectations of communications. It provides the following:

- The stakeholder communications requirements in order to communicate the appropriate information as demanded by the stakeholders.
- Information on what is to be communicated. This plan includes the expected format, content, and detail—thinks project reports versus quick e-mail updates.

- Details on how needed information flows through the project to the correct individuals. The communication structure documents where the information will originate, to whom the information will be sent, and in what modality the information is acceptable.
- Appropriate methods for communicating include e-mails, memos, reports, and even press releases.
- Schedules of when the various types of communication should occur. Some communications, such as status meetings, should happen on a regular schedule, while other communications may be prompted by conditions within the project.
- Escalation processes and timeframes for moving issues upwards in the organization when they can't be solved at lower levels.
- Methods to retrieve information as needed.
- Instructions on how the communications management plan can be updated as the project progresses.

Identify the 5Ws (Why, What, When, Where, Who) and 1H (How)

- Who needs to be communicated to? This is based on the communication formula and needs to be determined.
- What needs to be communicated? All information related to the project need not be communicated to everyone in the team.
- When it should be communicated. The timeline of communication should be monitored.
- Where should it be communicated? If the team involves many people, then individual level and team level communications needs to be resolved.
- Why communication of information is essential and to what level is important. Why is it not encouraged as it is blame rather than change?
- How the communication needs to be done. Is it conducted via e-mail, phone, or a presentation done to the team members?

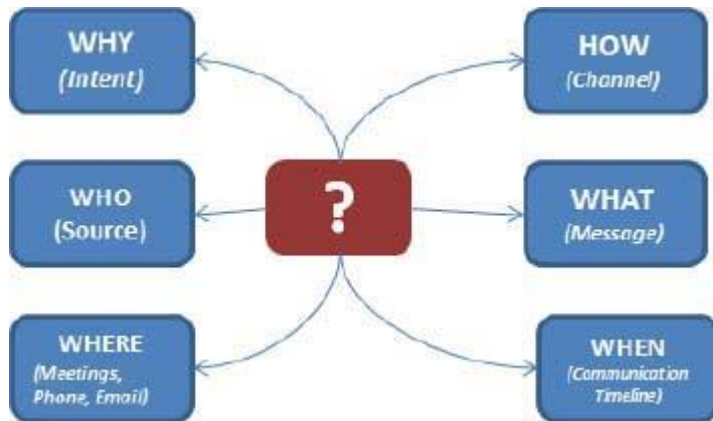

In order to understand major obstacles that come a long way in a project, it is essential to know the interfaces any project may have. The interfaces are as follows:

- Between organizations (e.g., customer-supplier);
- Between departments within an organization (e.g., marketing-IT);
- Between teams within a department (e.g., testers-developers); and
- Within distributed teams (e.g., part of the team is in Seattle and the other in Sydney).

The main communication obstacles (across interfaces listed earlier) can be drilled down to the following three broad areas:

Political: Whenever there are many groups involved, there is the possibility of vested interests and power games getting in the way of dialogue. Such political obstacles usually originate in the upper ranks of an organizational hierarchy, a step or two above levels at which projects are planned and executed. Project managers therefore need to make special efforts to be aware of the key political players in the organization. In traditional corporate environments, these might be functional or senior-level managers who are not always obvious project stakeholders.

Once the political players have been identified, the project manager should take steps to gain their confidence and buy-in on project goals. This should help eliminate political barriers to project communications. It is best to settle political issues at the level where they originate; escalating political problems up the hierarchy (i.e., to the manager's manager) generally does not help, and may even be counterproductive.

Cultural: Organizational culture, which is essentially the totality of assumptions and values commonly held within an organization need to be dealt with. Clearly, this can

vary considerably between organizations—some may be more open than others may, for example. Communication at the interface between two organizations with vastly differing cultures can be difficult. For example, one might expect some differences of opinion at a joint project planning session involving a very forward-looking, can-do supplier and a conservative, risk-averse customer. Project managers can ease such difficulties by understanding the divergences in attitudes between the parties involved, and then acting as intermediaries to facilitate communication. In geographically distributed (or virtual) teams, differences between regional cultures can come into play. These could manifest themselves in a variety of ways, such as differences in fluency of language or social attitudes and behaviors. Here again, the project leader, and the rest of the team for that matter, need to be aware of the differences and allow for them in project communications.

Linguistic: Linguistic needs to be understood in the sense of specialized terminology used by different disciplines such as accounting, IT, marketing, etc. Often when specialists from diverse areas get together to discuss project related matters, there is a tendency for each side to make assumptions (often tacitly) regarding a common understanding of specialized jargon. This often leads to incomplete (at best) or incorrect (at worst) communication. So practical techniques that would solve the above three obstacles needs to be identified and implemented. In other words, communication sharing should be best at any project level.

Learning Unit – 2:

Conduct information-management activities

Overview: The purpose of this learning unit is to inform the learner to conduct information-management activities.

Explain importance of managing risk by treating information securely

What is Information Security Risk Management?

Information security risk management, or ISRM, is the process of managing risks associated with the use of information technology. It involves identifying, assessing, and treating risks to the confidentiality, integrity, and availability of an organization's assets. The end goal of this process is to treat risks in accordance with an organization's overall risk tolerance. Businesses shouldn't expect to eliminate all risks; rather, they should seek to identify and achieve an acceptable risk level for their organization.

Stages of ISRM (Information Security Risk Management):

1. Identification

- Identify assets: What data, systems, or other assets would be considered your organization's "crown jewels"? For example, which assets would have the most significant impact on your organization if their confidentiality, integrity or availability were compromised? It's not hard to see why the confidentiality of data like social security numbers and intellectual property is important. But what about integrity? For example, if a business falls under Sarbanes-Oxley (SOX) regulatory requirements, a minor integrity problem in financial reporting data could result in an enormous cost. Or, if an organization is an online music streaming service and the availability of music files is compromised, then they could lose subscribers.
- Identify vulnerabilities: What system-level or software vulnerabilities are putting the confidentiality, integrity, and availability of the assets at risk? What weaknesses or deficiencies in organizational processes could result in information being compromised?
- Identify threats: What are some of the potential causes of assets or information becoming compromised? For example, is your organization's data center located in a region where environmental threats, like tornadoes and floods, are more prevalent? Are industry peers being actively targeted

and hacked by a known crime syndicate, hackti visit group, or government-sponsored entity? Threat modeling is an important activity that helps add context by tying risks to known threats and the different ways those threats can cause risks to become realized via exploiting vulnerabilities.

- **Identify controls:** What do you already have in place to protect identified assets? A control directly addresses an identified vulnerability or threat by either completely fixing it (remediation) or lessening the likelihood and/or impact of a risk being realized (mitigation). For example, if you've identified a risk of terminated users continuing to have access to a specific application, then a control could be a process that automatically removes users from that application upon their termination. A compensating control is a "safety net" control that indirectly addresses a risk. Continuing with the same example above, a compensating control may be a quarterly access review process. During this review, the application user list is cross-referenced with the company's user directory and termination lists to find users with unwarranted access and then reactively remove that unauthorized access when it's found.

2. Assessment

This is the process of combining the information you've gathered about assets, vulnerabilities, and controls to define a risk. There are many frameworks and approaches for this, but you'll probably use some variation of this equation:

Risk = (threat x vulnerability (exploit likelihood x exploit impact) x asset value) - security controls

3. Treatment

Once a risk has been assessed and analyzed, an organization will need to select treatment options:

4. Communication

Regardless of how a risk is treated, the decision needs to be communicated within the organization. Stakeholders need to understand the costs of treating or not treating a risk and the rationale behind that decision. Responsibility and accountability needs to be clearly defined and associated with individuals and teams in the organization to ensure the right people are engaged at the right times in the process.

5. Rinse and Repeat

This is an ongoing process. If you chose a treatment plan that requires implementing a control, that control needs to be continuously monitored. You're likely inserting this control into a system that is changing over time. Ports being opened, code being changed, and any number of other factors could cause your control to break down in the months or years following its initial implementation.

There are many stakeholders in the ISRM process, and each of them have different responsibilities. Defining the various roles in this process, and the responsibilities tied to each role, is a critical step to ensuring this process goes smoothly.

Process Owners: At a high level, an organization might have a finance team or audit team that owns their Enterprise Risk Management (ERM) program, while an Information Security or Information Assurance team will own ISRM program, which feeds into ERM. Members of this ISRM team need to be in the field, continually driving the process forward.





Risk Owners: Individual risks should be owned by the members of an organization who end up using their budget to pay for fixing the problem. In other words, risk owners are accountable for ensuring risks are treated accordingly. If you approve the budget, you own the risk.

In addition to risk owners, there will also be other types of stakeholders who are either impacted by, or involved in implementing, the selected treatment plan, such as system administrators/engineers, system users, etc.

Practical Activity # 1

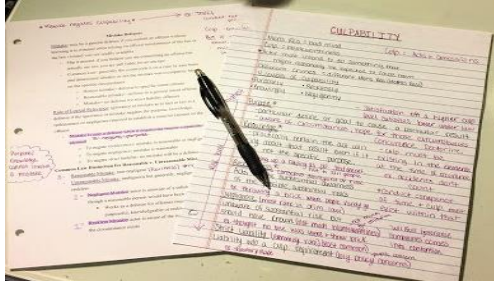
Role-play for gathering information and implementing project details

Module: 10	Apply Information and Communication Skills	
	Learning Unit: 1-2	Contribute to communications planning Conduct information-management activities
	Practical Description:	Role-play exercise for gathering information and implementing data where required in project
Time:	12 Hours	
Equipment	n/a	
Tools	n/a	
PPE	n/a	
Materials	n/a	
Key Point	Refrain from distractions when collecting information	
Learning Outcome:	<ul style="list-style-type: none"> • Contribute in gathering relevant information requirements to start project documentation • Contribute to developing and implementing the project <ul style="list-style-type: none"> ○ Communications plan • Communications networks • Act on project information according to agreed procedures as directed, to aid decision-making processes throughout project life cycle • Maintain information to ensure data is secure and auditable 	
Precautions:	All relevant information must be properly documented to avoid clutter	
Instructions	Illustrations	

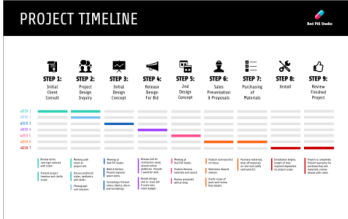
<p>1. Identify what information is required for the current project</p>	
<p>2. Put keywords on a piece of paper to search the web</p>	
<p>3. Document each collected information into a folder to avoid clutter</p>	
<p>4. Share the relevant information with each operator respectively</p>	
<p>5. Ask the operator to keep the information to the relevant personnel and also if the information is useful otherwise re-lookup the information</p>	
<p>6. Incorporate the information in the project plan and revise the timeline and roles</p>	

7. Finalize the project plan



Learning Unit – 3:

Communicate project information

Overview: The purpose of this learning unit is to inform the learner to communicate project information.

Identify organizational policies and procedures relevant to this role in a specific context.

The following steps summaries the key stages involved in developing policies:

1. Identify need

The organization needs to constantly assess its activities, responsibilities and the external environment in order to identify the need for policies and procedures. (More on what policies you need to develop).

2. Identify who will take lead responsibility

Delegate responsibility to an individual, working group, sub-committee or staff members, according to the expertise required. (More on the management committee's role in policy development).

3. Gather information

Do you have any legal responsibilities in this area? Is your understanding accurate and up to date? Have other organizations tackled the same issue? Are there existing templates or examples that you could draw on? Where will you go for guidance?

4. Draft policy

Ensure that the wording and length or complexity of the policy are appropriate to those who will be expected to implement it.

5. Consult with appropriate stakeholders

Policies are most effective if those affected are consulted are supportive and have the opportunity to consider and discuss the potential implications of the policy.

6. Finalize / approve policy

The Management Committee is responsible for all policies and procedures within the organization.

7. Consider whether procedures are required

Procedures are more likely to be required to support internal policies. Consider whether there is a need for clear guidance regarding how the policy will be implemented and by whom.

8. Implement

How will the policy be communicated and to whom? Is training required to support the implementation among staff and volunteers?

9. Monitor, review, revise

What monitoring and reporting systems are in place to ensure that the policy is implemented and to assess usage and responses? On what basis and when will the policy be reviewed and revised (if necessary)?

Learning Unit – 4:

Contribute to assessing effectiveness of communication

Overview: The purpose of this learning unit is to inform the learner to Contribute to assessing effectiveness of communication.

Outline methods of reviewing outcomes

Steps

1. Schedule Project Planning Review meeting
2. Distribute meeting materials
3. Conduct Project Planning Review meeting
4. Record decision

The initial Project Planning Review is held near the end of the Inception Phase, when the Software Development Plan is fully developed and includes a high level phase plan that the project team has a high degree of confidence in.

Subsequent Project Planning Reviews are held at scheduled points where the Software Development Plan is expected to be revised (e.g. at the end of each iteration). They are also held at "un-scheduled" points triggered by the need to make changes to the plan as a result of problems in the project.

Schedule Project Planning Review Meeting To top of page

Attendees of the Project Planning Review meeting should include representatives from senior management, and all groups that will have to commit resources to the project as required by the Software Development Plan (e.g., Development/Engineering, Operations, QA, Test, Customer Support, etc.). Typically these would comprise the Project Review Authority, along with team leads for the various functional areas of the project team.

Once the attendees of the Project Planning Review Meeting have been identified, set a date/time for the meeting to take place. It is important that you provide sufficient lead time to allow the participants to review the project materials that will be used as the basis for the approval decision.

Distribute Meeting Materials To top of page

Prior to the meeting, distribute the project materials to the reviewers. Make sure these materials are sent out sufficiently in advance of the Project Approval Review Meeting to allow the reviewers adequate time to review them. A minimum set of artifacts that should be presented for review is:

- Vision
- Business Case
- Risk List
- Software Development Plan (and its enclosed plans)

Conduct Project Planning Review Meeting To top of page

During the meeting, the reviewers assess the proposed Software Development Plan to determine whether it represents a program of activity that will deliver the project objectives. The reviewers also look for any erroneous assumptions or omissions in the plan. Consider such things as:



- Does the plan address the needs identified in the Business Case and Vision?
- Will the plan deliver the desired results within the schedule and budget outlined in the Business Case?
- Has the plan been developed to a sufficient level of detail that the outcome of the project can be realistically predicted?
- Have project estimates been prepared using sound analytical methods?
- Are review points and milestones scheduled at frequent enough intervals?
- Are plans in place to mitigate/avoid all serious risks?
- Are sufficient resources identified in the plan, and are these resources available/acquirable?
- Are roles and responsibilities clearly defined?
- Are the monitoring and control processes defined in the plan acceptable?
- Are all the supporting plans and guidelines completed to an acceptable level of detail?





Record Decision

At the end of the meeting, a Review Record is completed capturing any important discussions or action items, and recording the result of the Project Planning Review. If the result was "decision deferred" a follow-up Project Planning Review Meeting should be scheduled for a later date.

Practical Activity # 2

Role-play for information implementation

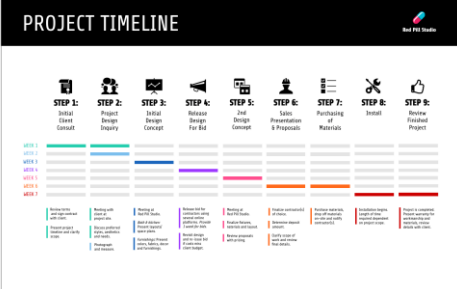
		Apply Information and Communication Skills
Module: 10	Learning Unit: 3-4	Communicate project information Contribute to assessing effectiveness of communication
	Practical Description:	Role-play exercise to discuss the roles for information implementation in the project and reviewing information usage
Time:	14 Hours	
Equipment	n/a	
Tools	n/a	
PPE	n/a	
Materials	n/a	
Key Point	Refrain from distractions when collecting information	
Learning Outcome:	<ul style="list-style-type: none"> Identify organizational policies and procedures relevant to this role in a specific context. Outline methods of reviewing outcomes 	
Precautions:	Information sharing should be monitored to avoid leakage	
Instructions		Illustrations
1. Identify which information is being shared with whom in the project		
2. Make sure that the operator understands the information being handed over and also understands where information can and will be shared		

<p>3. Document each collected information into a folder to avoid clutter</p>	
<p>4. Share the relevant information with each operator respectively</p>	
<p>5. Ask the operator to keep the information to the relevant personnel and also if the information is useful otherwise re-lookup the information</p>	
<p>6. Incorporate the information in the project plan and revise the timeline and roles</p>	
<p>7. Finalize the project plan and review if needed</p>	

Summary of the Module

In the Module of Apply Information and Communication Skills the following topics have been covered.

Identify the 5Ws and 1H

- Why
- What
- When
- Where
- Who
- How

Major obstacles that come a long way in a project

- *Political*
- *Cultural*
- *Linguistic*

Information Security Risk Management

Stages involved in developing policies

1. Identify need
2. Identify who will take lead responsibility
3. Gather information
4. Draft policy
5. Consult with appropriate stakeholders
6. Finalize / approve policy
7. Consider whether procedures are required
8. Implement
9. Monitor, review, revise

Schedule Project Planning Review meeting

Distribute meeting materials

Conduct Project Planning Review meeting

Record decision

Frequently Asked Questions (FAQs)

Question	Answer
1. What is the importance of communication in business?	Good communication can help the project process.
2. List the types of communication?	Communication is verbal and non-verbal
3. What are the differences in general and business communication?	General communication can be informal and direct. Business communication is more formal and precise.
4. What are the advantages of written communication?	Written communication means the participants are in binding with written.
5. What are the benefits of electronic communication?	Electronic communication is direct, immediate and can be encrypted if need be.

Self-Assessment

(MCQs)

Please mark the correct one from the given options. You can check your answer with the Answer Key at the end of this module

Q 1. In the communication process; in what form feedback is received?

- a) Liquid
- b) EXE file
- c) Message
- d) All of the above

Q 2. What can organize and document the process, types, and expectations of communications?

- a) Communication management plan
- b) Production plan
- c) Duty plan
- d) Shift plan

Q 3. What are the 5Ws of communication?

- a) Want, wire, wonder, winch and wool
- b) Why, What, When, Where and Who
- c) All of the above
- d) None of the above

Q 4. What does 'how' entails in a communication plan?

- a) Braking
- b) Relationship
- c) Channel
- d) Control

Q 5. What causes communication gaps?

- a) Communication obstacles
- b) Communication channels
- c) Communication plans
- d) Communication list

Q 6. What is the totality of assumptions and values commonly held within an organization?

- a) Interface
- b) Decoding
- c) Organizational culture
- d) Project management

Q 7. Lack of common understanding of jargons can lead to _____ communication?

- a) Incomplete
- b) Local
- c) Data
- d) Random

Q 8. What is ISMR?

- a) Internet Social Marital Record
- b) Information Security Risk Management
- c) Interface from Sub Memory Retrieval
- d) None of the above

Q 9. What is ERM?

- a) Employee Record Marriage
- b) Evening Routine Morning
- c) Event Recall Management
- d) Enterprise Risk Management

Q 10. At the end of the meeting, a Review Record is completed capturing any important discussions or action items, and recording the result of the Project Planning Review. This is called:

- a) Record decision
- b) Create team
- c) Installing data
- d) Locating profits

Answer Key

MCQ No.	Correct Answer
1	C
2	A
3	B
4	C
5	A
6	C
7	A
8	B
9	D
10	A

POST PRESS OPERATIONS (Publishing)

Learner Guide

National Vocational
Certificate Level 5

Version 1 - December 2019

Module-11

Module 11: - Perform Color Management

Learning Unit:

After completion of this module the learner will be able to:

LU1: Control L*a*b* values

LU2: Control drying parameters

Learning Unit – 1:

Control L*a*b* values

Overview: This learning unit deals with color management, ΔE , process colors, L*a*b* values and its matching mechanism. The learner will be able to match color L*a*b* values with given reference as per docket/job card, maintain Delta E (ΔE) of colors within the specified range during production.

Define color management & Enlist process colors

Process colors:

Do you know?

The “K” doesn’t technically stand for black; it stands for “key plate,” which is the plate of a printing press that carries the black

Process color is produced by printing a series of dots of different colors.

All the colors are created from layers of four primary colors CMYK (Cyan, Magenta, Yellow and Black) in halftone dots to create a full color effect. This is called 4-color process (CMYK).

To reproduce a color image, a file is separated into four different colors: Cyan (C), Magenta (M), Yellow (Y) and Black (K) then original image is created.

During separation, screen tints comprised of small dots which are applied at different angles to each of the four colors. The screened separations are then transferred to four



different printing plates, one for each color, and run on a printing press with one color overprinting the next. The composite image is perceived by the naked eye with the illusion of continuous tone.

Spot Colors:

In offset printing, a spot color is a color generated by an ink (pure or mixed) that is printed using a single run.

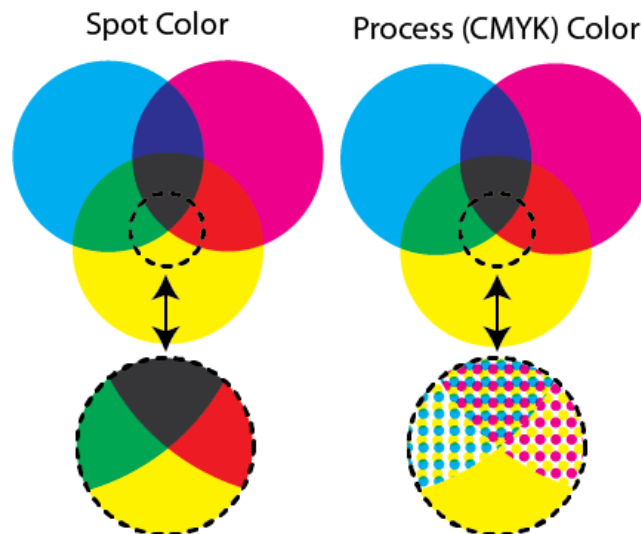

A spot color is a special premixed ink that is used instead of, or in addition to, process inks, and that requires its own printing plate on a printing press. Use spot color when few colors are specified and color accuracy is critical.

When there is a need to match a particular color (a background or specific color i.e. in a logo) during printing on substrate, the use of a spot color is carried out.

Color Measurement & Color Management

Color management:

It is the controlled conversion between the color representations of various devices, such as image scanners, digital cameras, monitors, TV screens, film printers, computer printers, offset presses, and corresponding media.

CIE color standard

Color management requires understanding of standardized process which provides structured methods and reliable repeated data that save time in process.

Color is an optical phenomenon, but a sensory impression converted by eye and brain. Color is not a physical variable therefore it has no physical unit. An object is not colored, but the sensation of color is produced as a result of reflection of light. An object that reflects red light of a visible spectrum appears red by our brain. An object that reflects completely entire visible light appears to be white and object that absorbs lights appears to be black.

The primary goal of color management is to obtain a good color match across different platforms, like Pre-press, Press and Viewing environment.

Do you know?

An object is not colored, but the sensation of color is produced as a result of reflection of light.

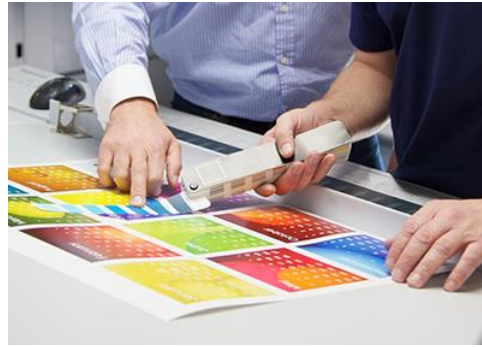

In 1931, CIE (Commission International de l'Eclairage) a French Organization took big step in creating standardized system of color measurement by specification of spectral properties (e.g. light prism) of standard illuminants (light) and information concerned with standard observers and color description approaches.

CIE Color illuminates

CIE has defined many standards for illuminants so far. The one mostly related to printers are listed in the following table:

Standard	Nature of Light Source	Color Temperature of Light Source
A	Typical Lamp	2856 K
C	Fluorescent Lamp (Rich in Blue)	6800 K
D 65	Average Indoor Light	6504 K
D 50	Warm Indoor Daylight	5083 K

Note:

Although these standards are displayed in the form of spectral energy distribution and available to be used in the counting of chromaticity, it is impossible to obtain corresponding light sources of the same spectral energy distribution. For instance, "light" lamps are used to represent D 65 and D 50 illuminants, for color observation, which are the light sources closest to the standards and available to printing houses. The following graph illustrates the comparison between D 65 Standard illuminants and typical light source of fluorescent lamp.

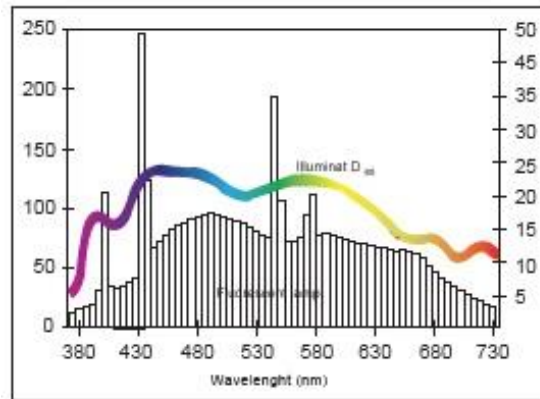

Define CIE L*a*b* Values:

CIE (International Commission on Illumination) built a more uniform color system around how humans perceive color: this is the CIE L*a*b*. CIE Lab represents colors by using the coordinates in a uniform color space consisting of lightness variable and chromaticity indices.

L*a*b* is a color space defined by International Commission on Illumination. L*a*b* values are used to standardize color values in a mathematical manner so that any device or person can perceive the same color as required by the job.

All the colors are created from four basic process colors CMYK (Cyan, Magenta, Yellow and Black). L*a*b* values represent a 3-dimensional graph (x, y, z axis) or a color space gamut where L* is on Z-axis. In another words the central vertical axis which represents lightness values, the value range is from 0 (black) to 100 (white). The lower the value of color, the darker it gets (e.g. 15 L* means Black) and higher the value of the color, lighter the color gets (75 L*).

CIELab Plan View

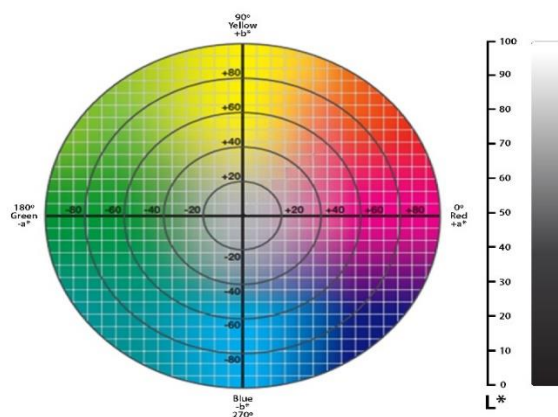

The a-a' axis, which runs from positive to negative, indicates amounts of red and green so this mean a* on the X-axis is represents the mix of green and red where negative is greener (e.g. -0.42 a*) and positive is redder (e.g. +0.42 a*) and The b-b' axis, which runs from positive to negative, indicates amounts of yellow and blue that is b* on the Y-axis represents the mix of yellow and blue where negative is bluer (e.g. -0.42 b*) and positive is yellower (e.g. +0.42 b*).

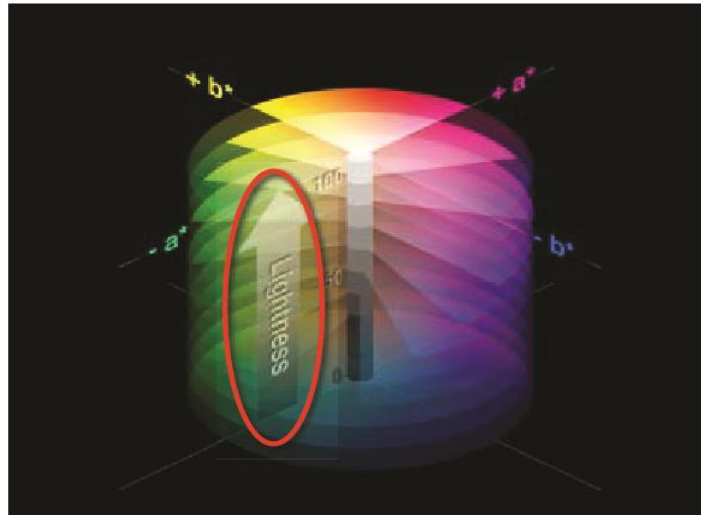

Procedure of LAB matching

Although we have discussed how to define colors with CIE standards, we still need to find an approach for evaluating reflective lights of samples, for actual measurement. Moreover, we need to measure and learn tristimulus values, which can be acquired with a **Spectrophotometer** or a colorimeter. The methods used by the two devices are quite different from each other, although both can provide tristimulus values.



Tristimulus values:

Are three values used together to describe a color and are the amounts of three reference colors that can be mixed to give the same visual sensation as the color considered

Spectrophotometer measures the intensity of light reflected from the samples, with an interval of 5, 10 or 20 nm, according to different devices. We collect the corresponding discrete values in the whole visible spectrum, enabling the spectrophotometer to provide integrated spectral reflectance curves, and XYZ tristimulus values can be calculated from these curves.

The **Colorimeter** is quite similar to the densitometer in many aspects, measuring reflective lights of samples with photoelectric cell of color filters. Due to the selection of filters, spectral sensitivity is similarly matched to the CIE Color matching function.

This method can provide only limited precision since it is very hard to find filters matching precisely with the CIE color matching function. However, it provides a convenient way to fabricate simple and inexpensive spectrophotometric measurement devices. Since the whole spectral reflectance curves are not provided, the colorimeter cannot indicate the metameric (Changing of color in various density of light and angle) of color matching.

Nowadays, portable spectrophotometer, similar to portable densitometer, is also available; they are simple and convenient. However, densitometer, colorimeter and Spectrophotometer of different designs may get different results on the same sample, since colors of an object are, to a large extent influenced by gloss reading and illuminating angles. Different devices may use different geometric conditions for illumination and observation. A device on the desktop calculates the integral of light reflected from the sample, or receives light in the integrating sphere and reflected from the sample (it is optional to include or not include mirror reflected). The relatively cheaper device is usually used for color measurement in the printing industry by treating the sample at an angle of 0° or 45° and measuring from the angle of 45° or 0° . Therefore the mirror reflectance is eliminated. Due to the difference of these geometric conditions, values acquired from a device cannot easily be compared, with the values directly acquired from another device of different design. Although established international measurement standards are available, difference also exist in the reading, because of different designs in the measuring instruments.

Describe delta E (ΔE) (Color Variation)

The variance in color values is represented by ΔE .

ΔE is the measure to understand how human eye perceives color difference between two samples. ' Δ ' is a mathematical term which represents change. ΔE value will range from 0 to 100.

Delta E (ΔE) is a single numerical value indicating the difference between printed color and desired color. This difference is expressed by the geometric distance between two colors.

Although the calculation of color difference was defined based on the color vision of the human eye, some color differences are evaluated differently between the color difference (ΔE) and the human eye. This is because the color discrimination of the human eye greatly differs from the range of (ΔE) color differences defined by CIE $L^*a^*b^*$. Sensitivity to color differences is low for the colors with high saturation.

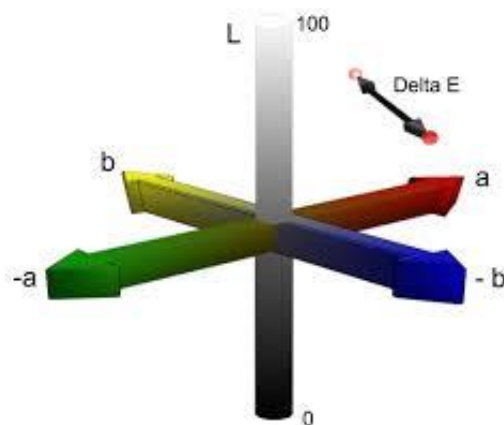

Delta E (ΔE)	Perception
≤ 1.0	No perceptible by human eyes.
1 - 3	Perceptible through close observation
4 - 10	Perceptible at a glance
11 - 49	Colors are more similar than opposite
100	Colors are exact opposite

DENSITY

Density has traditionally been used as the primary means to control the printing process. It has been widely held that it correlates well with the amount of colorant that is put on the paper over a limited range of ink film thicknesses. In addition, it is a convenient metric to use in a production environment, since it provides insight through a one-dimensional variable by which press operators can judge whether too much or not enough ink is being laid on a given substrate.

This article is going to focus on the theory of density and dot gain. The next article is going to be on the theory of colorimetric. Having the theoretical understanding of these concepts will help in understanding the statistical process control and quality control systems that benefit printing operations.

Definition

Density, or reflective density to be more accurate, is a measure of the percentage of reflected light. In printing processes, this usually means the percentage of light that is reflected from the substrate and the ink

Dot gain

Dot gain, or tonal value increase, is a phenomenon in offset lithography and some other forms of printing which causes printed material to look darker than intended. It is caused by halftone dots growing in area between the original printing film and the final printed result. In practice, this means that an image that has not been adjusted to account for dot gain will appear too dark when it is printed.[1] Dot gain calculations are often an important part of a CMYK color model.

Definition

It is defined as the increase in the area fraction (of the inked or colored region) of a halftone dot during the prepress and printing processes. Total dot gain is the difference between the dot size on the film negative and the corresponding printed dot size. For example, a dot pattern that covers 30% of the image area on film, but covers 50% when printed, is said to show a total dot gain of 20%.

However, with today's computer-to-plate imaging systems, which eliminates film completely, the measure of "film" is the original digital source "dot". Therefore, dot gain is now measured as the original digital dot versus the actual measured ink dot on paper.

Mathematically, dot gain is defined as:

$$\text{DG} = a_{\text{print}} - a_{\text{form}}$$

Where a_{print} is the ink area fraction of the print, and a_{form} is the prepress area fraction to be inked. The latter may be the fraction of opaque material on a film positive (or transparent material on a film negative), or the relative command value in a digital prepress system.

Learning Unit – 2:

Verify drying parameters

Overview: This learning unit explains about the drying agents used in printing industry. It also states the application of drying agents.

Define ink density

Density or reflective density to be more accurate, is a measure of the percentage of reflected light. In printing this usually means the percentage of light that is reflected from the paper and the ink. It is a convenient metric to use in a print production environment, since it provides insight through a one-dimensional variable by which press operators can judge whether too much or not enough ink is being laid on the paper.

It is one variable of many used for controlling color on press.

How does the ink dry?

The drying of the ink is a combination of a physical phenomenon “penetration into the substrate” and a chemical phenomenon “air oxidation”.

Penetration into the substrate

During printing, as soon as the ink is deposited on the substrate, certain ingredients of the ink penetrate into the substrate. These are liquid ink components, i.e. mineral or vegetable diluents like fats. Mineral diluents, which are more fluid, have a tendency to penetrate more quickly than vegetable diluents. The rapidity and ease with which they penetrate depends on the quality, surface condition and porosity of the substrate. If the substrate is more porous, then the penetration process will be faster. In the case of non-absorbent substrate such as tracing paper or synthetic substrates, no penetration occurs. Drying is entirely through air oxidation.

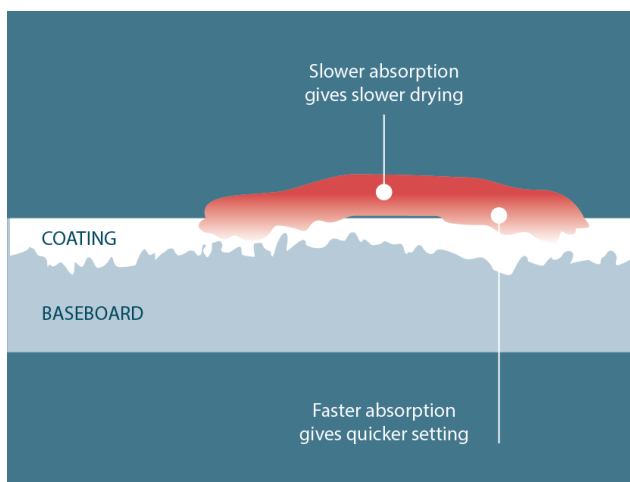

Air oxidation

This chemical phenomenon begins as soon as the print leaves the press. Air oxidation corresponds to the hardening of the varnishes in the ink through a chemical process that occurs on contact with oxygen in the air. In the first stage, the reaction begins on the surface of the ink film and then spreads throughout the body of the film. This air oxidation mechanism can be accelerated on the press itself by adding drying agents to the ink.

The drying of the ink, whatever its formulation, involves the two above mentioned phenomena. By adjusting the mix of the ink, the balance can be switched towards penetration or air oxidation.

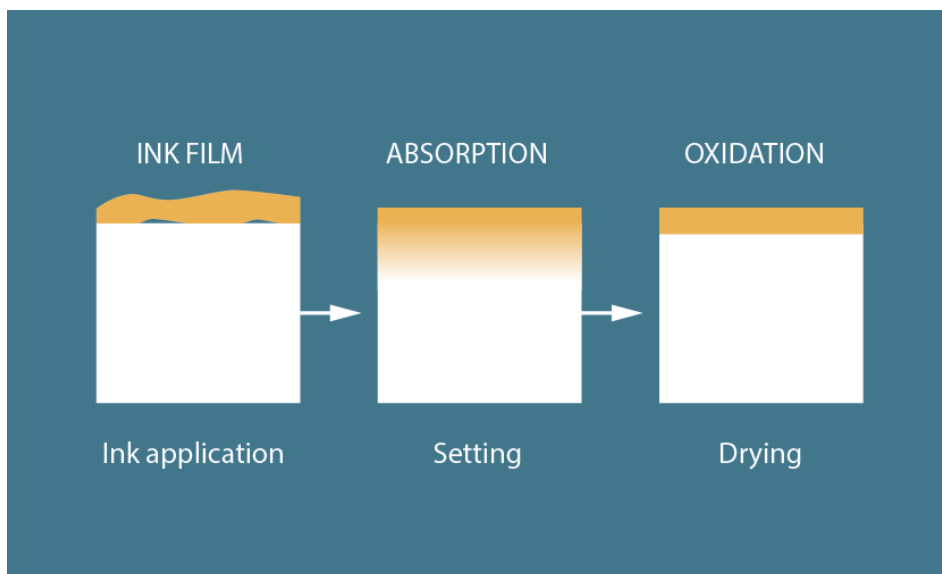

Common reasons of applying drying agents

1. Excessive ink application
2. Low pH value of the paper/board and/or the fountain solution.
3. Low concentration of drying components of inks.
4. High dosage of fountain solution.
5. High moisture content of paper/board.
6. Ink composition
7. Low temperature or high air moisture in the printing room.
8. Viscosity of inks and varnishes.

Corrective measures:

1. Decrease of ink application.
2. Adjust the pH of the fountain solution from 4.5 – 5.5
3. Add drying compounds to inks. This must be done with the assistance of ink supplier.
4. Reduce the dosage of fountain solution.
5. Replace the paper/board with high moisture. Avoid exposing the board to moist environments.
6. Try using the newest ink batches. Ask for technical assistance of ink supplier.
7. Control the moisture and temperature to a range of 20 – 23 °C (68 – 74 °F) and 50 - 60% of relative moisture.

**8. Other actions:**

- a. Use of anti-set-off powder.
 - b. Add dryness enhancers to fountain (Chiller tank).
9. Use higher pigmentation ink. Higher the pigment ratio, less ink deposit required to obtain ink density.

Drying agents:

There are two basic types of drying agents used in offset printing; fountain dryers and ink dryers.

Fountain Dryer should be added to premixed fountain solution. Once Fountain Dryer is added to the fountain (water), ink will start to oxidize (dry) the top layer.

Ink Dryer is an ink additive that has a catalyst for cross linking reactions. Ink dryers attach itself to the pigment and varnishes in the ink and then attaches to the substrate. Its properties then create a chemical reaction that allows drying from top to bottom and side to side at the same time. It also increases rub resistance, eliminates chalking and also keeps the inks characteristics of body and tack unchanged.

Under certain conditions in the offset printing process, problems with the drying of inks can appear. Often these defects are identified as scum and release of inks; also the drying of inks can take longer than required, which has an impact on printing quality.

In case of excessive dosage of dryer the following problems can occur:

1. It is going to have an adverse effect on the ink film
2. It drastically impacts the tack of the ink
3. Causes stripping issues on the rollers

Application of drying agents:

All manufacturers of drying agents provide application specifications on their respective packaging.

Drying agents vary with their chemical and physical characteristics therefore they should be applied as per manufacturer's specifications.



In order to get proper drying, the following characteristics need to be monitored:

- pH Value using pH meter/strips
- Conductivity using conductivity meter
- Chiller temperature
- Isopropyl alcohol (IPA) Ratio
- Fountain solution ratio according to the pH of water.

Practical Activity # 1

Verify the printed material from docket

		Perform Color Management
Module: 11	Learning Unit: 1-2	Check L*a*b* and density values Verify drying parameters
	Practical Description:	Verify the printed material from docket before post-press operation as per press SOP's
Time:	80 Hours	
Equipment	Spectro -densitometer	
Tools	Eye glass	
PPE	Gloves	
Materials	Printed Paper	
Key Point	Acceptance levels as per job requirement	
Learning Outcome:	<ul style="list-style-type: none"> • Match colour L*a*b* values with given reference as per docket/job card. • Verify Delta E(ΔE) of colours with in the specified range during production. • Verify colour density • Verify wet ink on sheets. • Check low stacks from the machine as per jo 	
Precautions:	Instrument should be well calibrated	
Instructions		Illustrations

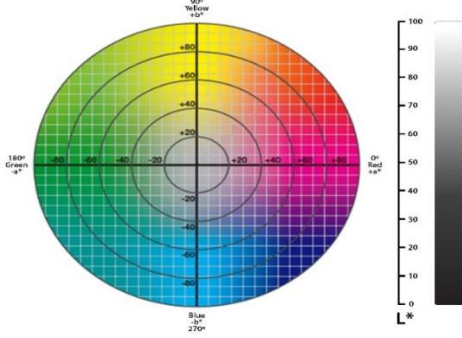
<ol style="list-style-type: none"> 1. Note job L*a*b* values and ΔE in the docket 	
<ol style="list-style-type: none"> 2. Use the spectrophotometer to get L*a*b* values on the printed sheet note these values next to the docket L*a*b* values 	
<ol style="list-style-type: none"> 3. Calculate the ΔE by subtracting the printed sheet's L*a*b* values from docket L*a*b* values 	<h3>CIELab Plan View</h3> 
<ol style="list-style-type: none"> 4. Compare the ΔE from the ΔE in the docket 	
<ol style="list-style-type: none"> 5. If the ΔE value is more than that in the docket repeat the above steps with another sheet to verify if the deviation is consistent 	
<ol style="list-style-type: none"> 6. Determine if the deviation in ΔE can be adjusted in post-press 	

Summary of the Module

- Process color is produced by printing a series of dots of different colors. All the colors are created from layers of four primary colors CMYK (Cyan Magenta Yellow and Black) in halftone dots to create a full color effect.
- Color management is the controlled conversion between the color representations of various devices, such as image scanners, digital cameras, monitors, TV screens, film printers, computer printers, offset presses, and corresponding media. The primary goal of color management is to obtain a good color match across different platforms, like Prepress, Press and Viewing environment.
- $L^*a^*b^*$ values are used to standardize color values in a mathematical manner so that any device or person can perceive the same color as is required by the job.
- ΔE (Delta E) is the measure to understand how human eye perceives color difference between two samples. ' Δ ' is a mathematical terms which represents change. ΔE value will range from 0 to 100.
- The drying of the ink is a combination of penetration into the substrate and air oxidation. Ink penetration is very dependent on the type of substrate printed. By adjusting the mix of the ink, the balance can be switched towards penetration or air oxidation.
- There are two basic types of drying agents used in offset printing; fountain dryers and ink dryers. All manufacturers of drying agents provide application specifications on their respective packaging. In order to get proper drying, the following instruments need to be monitored; pH meter, Conductivity meter, chiller temperature scale, Level of water in tank through visual confirmation, IPA Ratio and Fountain solution ratio.

Frequently Asked Questions (FAQs)

Question	Answer
1. What does "K" stand for in CMYK?	<i>It stands for "key plate," which is the plate of a printing press that carries the black ink.</i>
2. Define spot color.	A spot color is a special premixed ink that is used instead of, or in addition to, process inks
3. What are process colors?	A process color is printed using a combination of the 4 standard process ink: cyan, magenta, yellow and black (CMYK).
4. Why color management is important?	The primary goal of color management is to obtain a good color match across different platforms, like Prepress, Press and Viewing environment.
5. What is the purpose of Spectrophotometer?	Spectrophotometer measures the intensity of light reflected from the sample
6. What is ΔE ?	ΔE is the measure to understand how human eye perceives color difference between two samples.
7. What L*a*b* values mean?	L*a*b* values are represented a 3-dimensional graph (x, y, z axis) or a color space gamut
8. What does L*a*b* denotes?	L --lightness a --redness/ greenness b --yellowness/blueness
9. What is density?	Density is the level of darkness in a negative or positive film or print.
10. How many types of drying agents are used in offset printing?	There are two types of drying agents: Fount dryer and ink dryer

Self-Assessment

(MCQs)

Please mark the correct one from the given options. You can check your answer with the Answer Key at the end of this module

Q 1: Which of the following is NOT a common cause for non-drying of ink?

- a) High moisture content of substrate
- b) High air moisture in the printing room
- c) Low pH value of the fount solution
- d) Color of the ink

Q 2: When not drying, which of the following corrective actions can fix the problem?

- a) Change printing plates
- b) Adjust the dosage of fountain solution
- c) Adjust $L^*a^*b^*$ value
- d) Use spectrophotometer

Q 3: Two basic types of drying agents are:

- a) Fount dryer and ink dryer
- b) $L^*a^*b^*$ and ΔE
- c) Conventional and alcohol
- d) Local and imported

Q 4: Which of the following is an effect of non-drying inks:

- a) Low dot count
- b) Non-aligned impression
- c) Bleeding
- d) Low $L^*a^*b^*$ values

Q 5: Conductivity is measured by:

- a) A spectrophotometer

- b) A pH meter
- c) A thermometer
- d) A conductivity meter

Q 6: The primary goal of ----- management is to obtain a good color match across different platforms. Like Prepress, Press and Viewing environment.

- a) Paper
- b) Time
- c) Ink
- d) Color

Q 7: Controlling amount of ink applied to printing substrate (Thickness of ink) is:

- a) Saturation
- b) Mixing
- c) Density
- d) cE

Q 8: Which of the following are Basic Printing Process colors?

- a) CMYK
- b) Spot Colors
- c) Special Colors.
- d) None of above

Q 9: What does delta E (ΔE) represents?

- a) Texture difference
- b) Intensity of brightness
- c) Color difference
- d) Difference between dot loss and dot gain

Q 10: Spectral values are represented by:

- a) Ink Densities.
- b) $L^*a^*b^*$.
- c) Percentage of Color.
- d) RGB

Answer Key

MCQ No.	Correct Answer
1	D
2	B
3	A
4	C
5	D
6	D
7	C
8	A
9	C
10	B

POST PRESS OPERATIONS (Publishing)

Learner Guide

National Vocational
Certificate Level 5

Version 1 - December 2019

Module-12

Module 12: - Develop Layout & Dummy

Learning Unit:

After completion of this module the learner will be able to:

- LU1: Perform manual sizing and layout
- LU2: Instruct Graphic designer for Art Work
- LU3: Develop a Dummy.

Learning Unit – 1:

Perform manual sizing and layout

Overview: The purpose of this learning unit is to inform the learner to manually perform sizing and layout.

Standard sizes of substrate

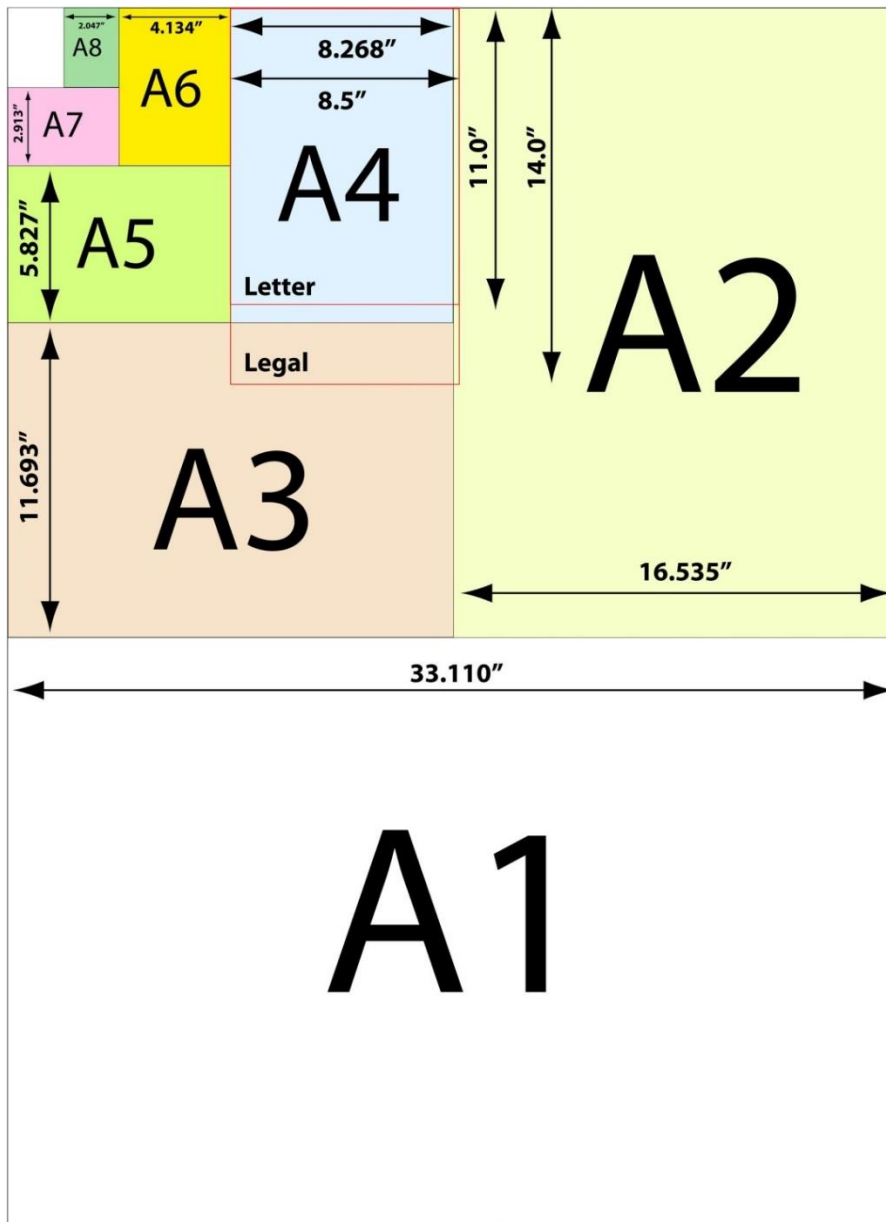

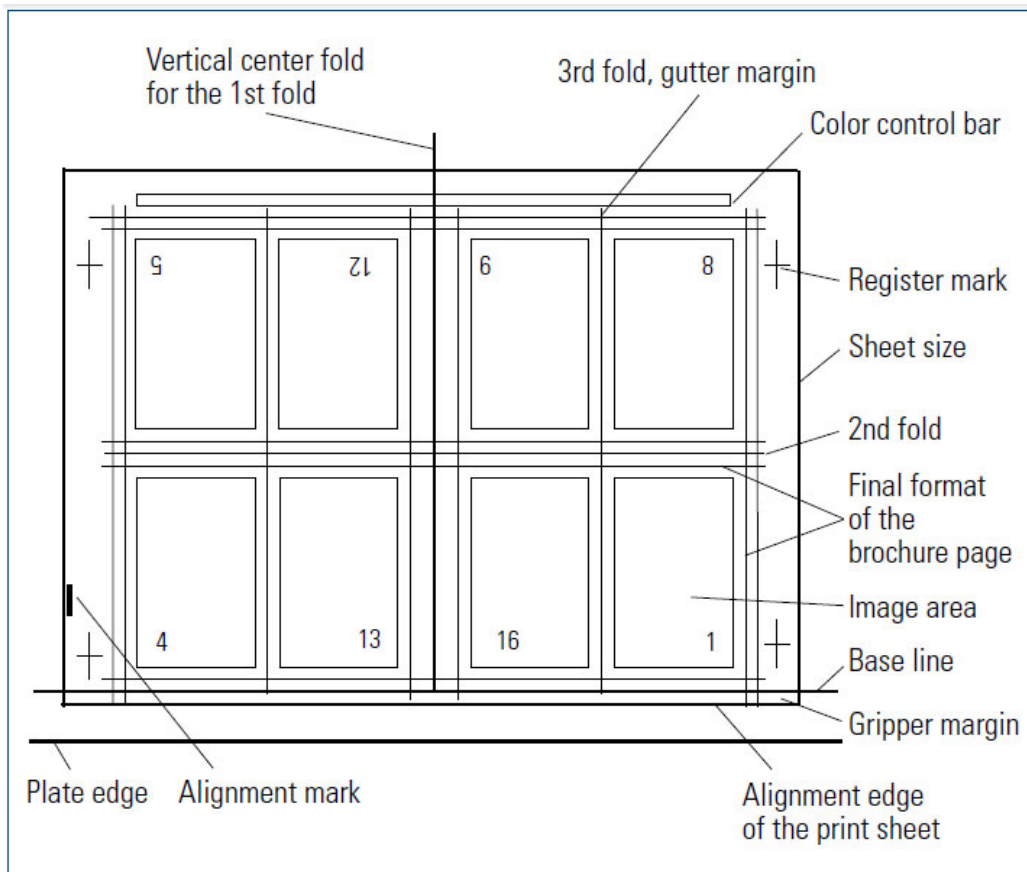

Identify side lay and front lay

To align the sheet on the feed table with the required accuracy, it is usually aligned at two front lays and one side lay (figure 1). On large format presses, which are equipped with six front lays, unneeded front lays are disengaged when smaller formats are processed, so that only two front lays are used for the alignment. To be able to align the printed sheets at the same side for the finishing operation, the alignment points have to be marked in the printed product (e.g., manual marking in the delivery pile). Whether these alignment points must then be used in finishing depends on the product and the required tolerances. Since there are different alignment systems in printing and finishing, it is very important for the front edges of the sheets to be cut as straight as possible and within narrow tolerances, as well as for the angle between the front and side edges to deviate as little as possible from an exact right angle.

The accurate position of the print image on the sheet can only be achieved if each sheet is aligned individually before it enters the press. During the actual alignment process, the sheet is pushed or pulled with light force against the alignment guides. Guide elements, such as belts, brushes, rollers, pulling

segments, or the suction plates of the side guides, slide gently over the sheet and, assisted by sliding friction, take it to the correct final position. It must be possible to adjust the sheet feeding systems to allow for the great variety of sheet sizes, the variable sheet thickness, and the different sliding friction of the different sheet surfaces.

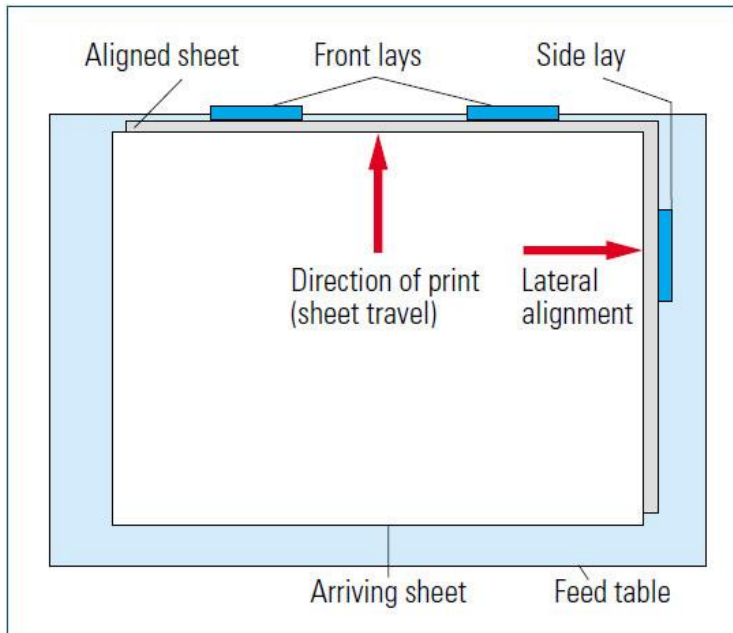

Side Lay

The side alignment of each individual sheet takes place at the side lay, by means of side lays. Side lays are press elements that ensure the exact lateral alignment of the sheet before it is transferred to the printing units.



Front Lay

The two front lays act as stops for the sheet, which is usually fed at low speed by conveyor belts via the feed table. The aim of this is the exact alignment of the sheet in the travel direction (direction of print). The front lays remain in their start position/alignment position until the swing-arm grippers close (figure 5). They are then moved out of the travel line of the sheet, before the swing gripper moves along with the sheet in the direction of the print. The front lays then return to their alignment position when the sheet makes contact with the front lay it has a tendency to bounce back slightly.

Practical Activity # 1

Substrate size measurement

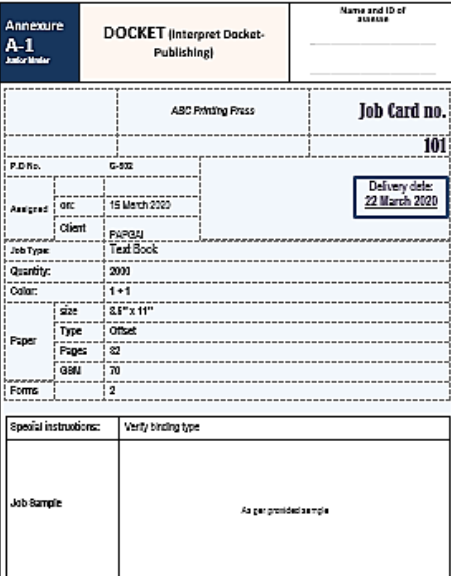
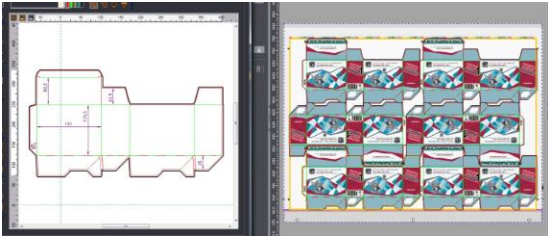
Module: 12	Develop Layout & Dummy	
	Learning Unit: 1	Perform manual sizing and layout
	Practical Description:	Measure size of substrate and verify from docket
Time:	25 Hours	
Equipment	n/a	
Tools	Measuring scale	
PPE	n/a	
Materials	Paper	
Key Point	The content area of the design must be monitored	
Learning Outcome:	<ul style="list-style-type: none"> • Verify side-lay & front-lay of the substrate. • Verify the color, type and size as per sample. • Make sketch of unit box on the large sheet. • Verify the thickness and GSM value of the substrate 	
Precautions:	Make sure that page content is not outside the trimming area	
Instructions		Illustrations

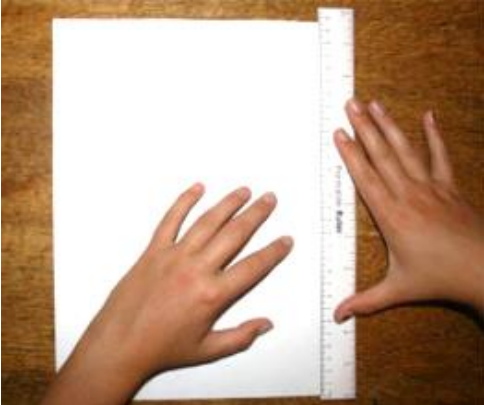
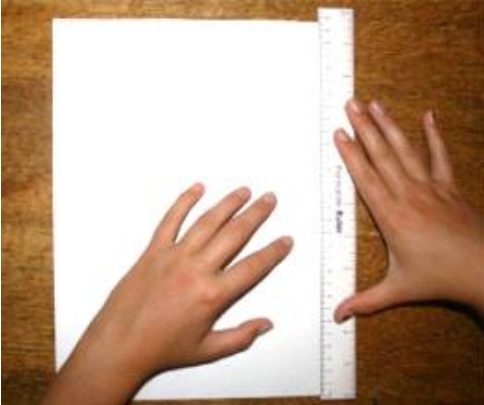
<p>1. Read the docket carefully for the substrate size</p>	 <p>The docket form includes the following information:</p> <ul style="list-style-type: none"> Annexure A-1 (Junior Master) DOCKET (Interpret Docket-Publishing) Name and ID of student: _____ ABC Printing Press Job Card no. 101 P.O. No. G-932 Assigned date: 15 March 2020 Client: PAPER24 Job Type: Text Book Quantity: 2000 Color: 1 + 1 Paper size: 8.5" x 11" Paper Type: Offset Pages: 32 GSM: 70 Forms: 2 Special instructions: Verty binding type Job Sample: As per provided sample
<p>2. Measure the art work to determine the number of ups</p>	 <p>The left image shows a digital art layout with dimensions and fold lines. The right image shows a physical printed sample of a book cover with a grid of pages.</p>
<p>3. Collect a blank sheet from raw material warehouse</p>	 <p>The photograph shows a large industrial warehouse with high ceilings, filled with numerous tall stacks of white paper.</p>
<p>4. Measure the collected sheet using measuring scale</p>	 <p>The photograph shows a person's hands holding a large white sheet of paper next to a vertical measuring scale to check its dimensions.</p>
<p>5. Ensure paper size as mentioned in the docket</p>	 <p>This image is identical to the previous one, showing a person's hands holding a large white sheet of paper next to a vertical measuring scale.</p>

Learning Unit – 2 & 3:

Instruct Graphic designer for Art Work

Develop a Dummy

Overview: The purpose of this learning unit is to inform the learner to create, adjust, check margin, folding, bleeding, and color and registration marks of an art board and develop a dummy.

Describe the purpose of layout

In printing, terms like Two-Up, Three-Up, Four-Up, and Multiple-Up etc. refer to the way artwork files and/or printing plates are designed, so that the printing press can apply more than one image to the paper at the same time.

A Two-Up format creates two images per press impression, a Three-Up format creates three images per press impression, a Four-Up format creates four images per impression and so on. In its purest sense, the term “Up” refers to multiple impressions of the same image at the same time. However, the term “Up” is also sometimes used to designate impressions of different images made at the same time. For example, it is common practice in book printing to print several different pages together in one press impression.

Let’s say you needed 1,200 printed flyers with a finished size of 8.5” x 11” each. If the layout and printing plate is designed to print 2-Up, then two 8.5” x 11” flyers could print side-by-side on a larger sheet with each press impression. Once 600 of these larger sheets cycle through the press and receive the 2-Up ink impression, they are cut apart to yield 1,200 flyers measuring 8.5” x 11” each.

Another example of “Multiple Up” printing is promotional rack cards, which are commonly designed 3-Up so that three cards print on one sheet of 8.5” x 11” cardstock. To produce 1,200 rack cards like this the press would only need to cycle 400 times, because the cards are being printed three at a time.

Likewise, the sheets of a 4.25” x 5.5” notepad could be designed to print 4-Up on 8.5” x 11” paper. This would allow four notepad sheets to print at one time, so the press would only need to cycle 300 times to produce 1,200 sheets. Or, the

same 4.25" x 5.5" notepad sheet could be designed to print 8-Up on 11"x 17" paper. This 8-Up scenario would only require 150 press cycles to produce 1,200 of the notepad sheets, since eight notepads sheets are printed at the same time.

Why Print Multiple-Up?

As you probably gathered from the above examples, the main reason for printing images "Multiple Up" is to reduce the amount of press time needed for a given production run. This extra efficiency results in cost savings for the production facility, which in turn allows them to charge less for the printing. Other benefits of printing "Multiple Up" include more cost-effective paper usage and reduced wear on printing plates.

By nature, the term "Up" implies a vertical arrangement of images. However, in printing and artwork design, that is not necessarily the case. For example, the term 2-Up could describe two images that are designed to print side by side as well as two images that print one above the other.

Basically, Multiple Up images could print in a horizontal row, a vertical column or any combination of rows and columns that provides efficient placement on the paper. It is also common for just a single image to print at a time, which would be referred to as 1-Up.

Describe the importance of CMYK color bar

Color bars (a.k.a. color control bars, color control strips, or proofing bars) are essentially test targets that are used to measure print and/or proof attributes. Normally, but not always, it is printed in the trim area of the press sheet. Typical placement of a color bar on an offset press sheet - at the trailing edge (back end of the sheet). However, it can take many different forms - sometimes hard to recognize - but always serving the same purpose. Sometimes it is hidden in the spine (in this case the grey line running from top to bottom on the front edge of the photo). Color bars act as proxies, or substitutes, for the live image area as well as provide additional data.

The logic behind color bars

- 1) Unlike the live image area of the press sheet, color bars are consistent job to job. Therefore they are more efficient at providing a benchmark and can be used to track trends in variation over time.
- 2) Color bars can be tailored to meet the needs and measurement capabilities of individual print shops.

- 3) Color bars may be used to measure all aspects of the "print characteristic" - solid ink density, overprinting (ink trapping), dot gain, grey balance, as well as issues such as slur and dot doubling.
- 4) Color bars can reveal issues with ink hue, blanket condition, impression cylinder pressure, etc.
- 5) They can be used forensically to help understand why a specific job did not meet expectations.
- 6) They are efficient since, unlike the live image area, they are a constant made up of well-defined elements that continue from proof to press sheet.

Solid ink density

A printing press is essentially a complex machine for laying down a specific film thickness of a specific color of ink onto a substrate. The ink is metered out in zones across the width of the press sheet according to how much ink coverage is required for each color in each zone. Therefore, for most press operators, the minimum requirement for a color bar is that it contains solid patches of the inks that will be printing since solid ink density is the only thing on press that an operator can adjust while the press is running. Those solid patches are then repeated over the width of the press sheet so that each ink zone is represented by at least one complete set of patches - containing one patch for each color being printed.

Forensic targets on color bars are image elements that are typically not measured by the press operator unless there is a problem in aligning presswork to the proof. If that happens then these targets may provide useful information as to the cause of the problem.

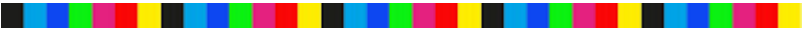
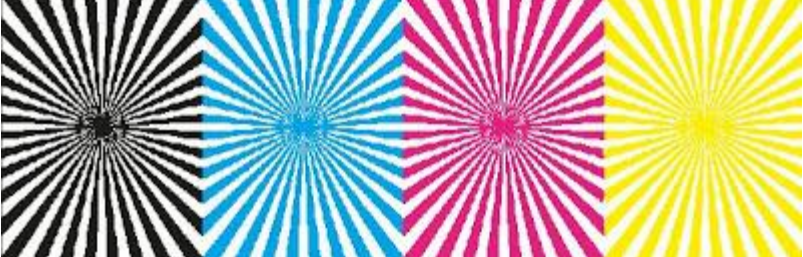
Two-color overprint ink trapping targets	
Slur and doubling targets	

Grey balance targets	
Dot gain	
Spot color	

Describe the importance of bleeding area

Bleed is a printing term that describes a document that has graphics, images, colors, or elements that reach to the edge of the paper, leaving no surrounding margins. Full bleed layouts are printed on a larger sheet and then trimmed.

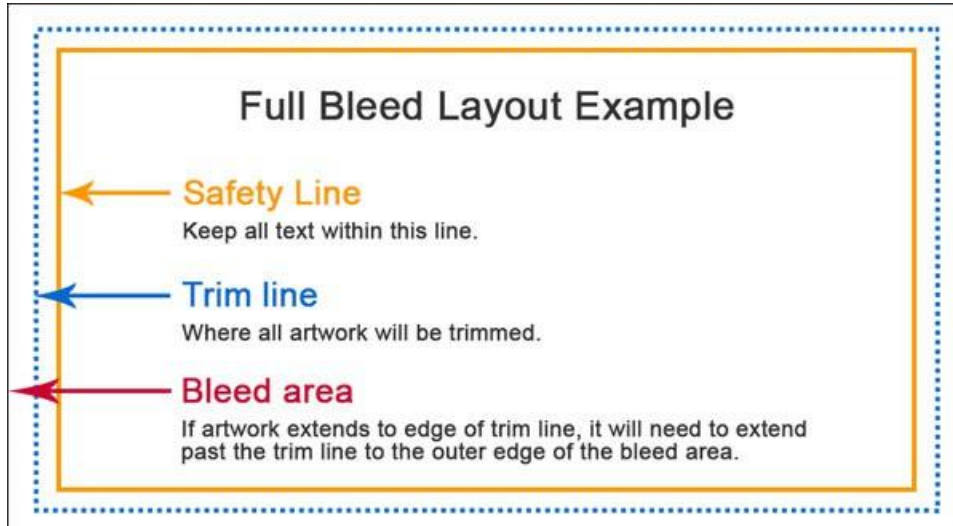

Full bleed layouts are layouts that allow the image to continue past the edge of the finished page, so that there is no visible margin between the image and the edge of the page. The method is commonly used in magazines, business cards, and brochures. It has become more popular in other types of printed materials as well because of the visual effect that it has on the viewer.

This type of layout can be used with almost any digital printing order, but it must be carefully planned far in advance of the printing process starting. The bleed aspect of the layout must be included during the initial design phase and stay consistent throughout. You cannot decide at the last minute that you want to use this layout format; it must be planned from the start.

Full bleed layouts offer a safety margin, because the ink continues past the edge where the page will stop so there is a little wiggle room if an error or miscalculation is made. Nothing screams inexperience and unprofessional than printed marketing or business materials that have an unintended white edge or margin around them.

The safety line is usually at least 1/8" away from the trim line to accommodate different cutting tolerances. When full bleed layouts are created the bleed line always needs to end outside of the trim line. The trim line indicates where each page will be trimmed, and you want to ensure that the bleed continues past this line so that the image flows off the page.

If you want to use full bleed layouts then one of the most important steps is to know the paper size and shape before you ever start to do any design work. This will help you calculate the live area, the trim line, and the bleed line effectively for your specific piece. If you are not sure on the paper shape or size then these factors are impossible to calculate.

One aspect of full bleed layouts is the live area. This is the area which is known to be safe, and which will appear even if the printer is sloppy or the edges of the page are trimmed more than specified. This is the area where the main part of the image will appear and it should include every design element that you want to appear on the printed page or other printed item. For example, if an ad's trim size is 8.25 in x 10.25 in, the live area might be 7.75 in x 9.75 in.

If you do the necessary research, evaluation, and printer comparisons, then getting exceptional full bleed printing results is almost guaranteed. If you hire the first printer that you find, whether looking at all of the important factors, then you may end up regretting your decision when you receive the printed materials and they are not what you expected. Take the time to find the best printer possible.

You should allow a minimum of ¼ inch to allow for full bleed, and even more if possible.

The finished size of the item will also be a consideration in how much space you should allow so that you get the full bleed effect and you do not have to worry about any unintended margins or graphics interruptions. Failing to leave enough space for bleed will negate the benefits of this type of layout.

Describe the importance registration marks

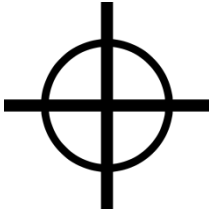

Registration marks print outside the trim area of printing. They can include bulls-eye targets, crop marks, plate information, etc. These marks allow the printer to accurately align separate plates for multiple colour print jobs and better align cuts when trimming.

In offset printing a job that has two or more colours that print up against each other or overprint each other, registration marks help you to set up each plate colour for a close printing with minimal to no adjusting.

Registration marks are required:

- If you have a printing design with bleeds, crop marks are useful for a proper paper trim after printing.
- If you are printing a design with scores and folding, having those marks designated outside your trim area is helpful for die cutting and finishing work.
- If you are sending your printing project to another location for cutting and finishing, registration marks can be a very smart move for a successfully trimmed job.

Trapping is the process of overlapping two inks (whether spot or process CMYK) into each other eliminating mis-registration of colours on the printing press. Look very closely and you'll see it everywhere on printed material. The golden rule is that the darker colour holds its shape and the lighter colour 'traps' into that shape. Trapping avoids any white shapes showing in between colours when inks are slightly out of register. 'Registration' is making sure each ink sits exactly over the top of each other and that each ink is registered with each other.

Trapping amounts vary depending on the quality of the printing press, the substrate or

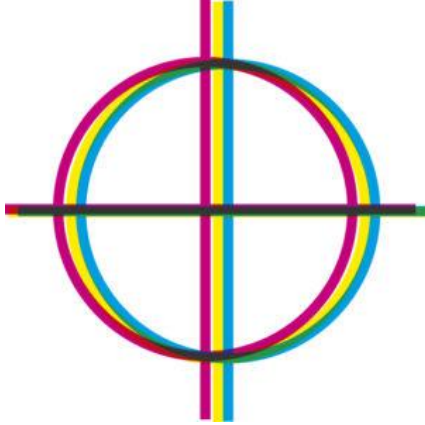

paper stocks used and the speed of the printing press. The faster the speed the more chance of the inks falling out of registration with each other as the sheets move through the press. It can be as thin as strokes 0.2 mm or as thick as 2mm. Your printer will set their preferred trapping amounts.



Practical Activity # 2

Adjust Ups according to art work

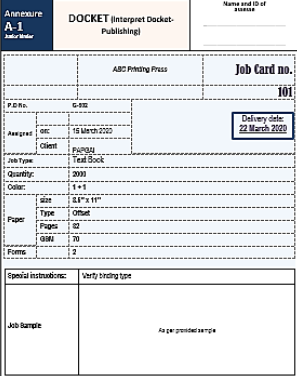
Develop Layout & Dummy	
Module: 12	Learning Unit: 2 Instruct Graphic designer for Art Work
	Practical Description: Place Ups on layout according to art work and substrate size
Time:	30 Hours
Equipment	Desktop system with graphical designing capabilities
Tools	Adobe illustrator / Adobe freehand
PPE	n/a
Materials	n/a
Key Point	Content are should be monitored
Learning Outcome:	<ul style="list-style-type: none"> • Create master art board sheet size. • Adjust Ups according to art board. • Check the margin of side-lay & front-lay of the substrate. • Check the folding / perforation margin of the substrate.

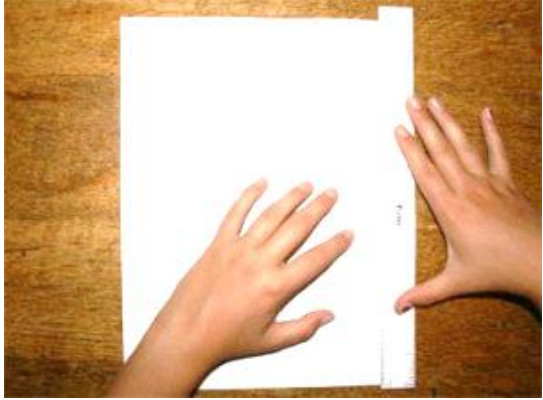
	<ul style="list-style-type: none"> • Add bleeding / over lapping for flash cutting. • Verify CMYK color bar on layout. • Check side-lay, cutting and registration marks. • Verify job card and form number on layout.
Precautions:	Layout should have all the requisite markings
Instructions	Illustrations
1. Read the docket carefully	
2. Measure art work on dummy	
3. Measure substrate	

4. Divide the substrate into Ups according to art work length and width



5. Place registration marks, color bar, trimming marks, folding marks etc.

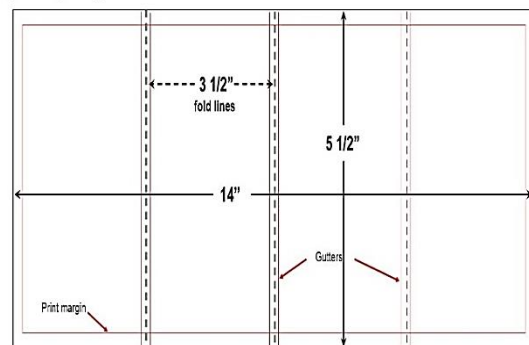

Practical Activity # 3

Develop a dummy

		Develop Layout & Dummy	
Module: 12	Learning Unit: 3	Develop a Dummy	
	Practical Description:	Develop a dummy of art work for the job	
Time:	25 Hours		
Equipment	Digital printer		
Tools	n/a		
PPE	n/a		
Materials	Digital printed material		
Key Point	Dummy should have all the critical characteristics of finish product		
Learning Outcome:	<ul style="list-style-type: none"> • Make a print out of actual size. • Create a Dummy. • Verify Dummy as per job. • Get approval from client. 		
Precautions:	Dummy should be made before pre-press operator		
Instructions		Illustrations	
1. Read the docket carefully			
2. Print the layout using the digital printer			

<p>3. Place the layout in formation as instructed in docket</p>

Summary of the Module

In the Module of Develop Layout & Dummy the following topics have been covered.

- Perform manual sizing and layout
- Instruct Graphic designer for Art Work
- Develop a Dummy

In the above mentioned topics some critical areas also briefed like:

Standard sizes of substrate

- Identify side lay and front lay

Describe the purpose of layout

- Describe the importance of CMYK color bar
- Describe the importance of bleeding area
- Describe the importance registration marks

Frequently Asked Questions (FAQs)

Question	Answer
1. What is the purpose of layout?	To put artwork Ups on a substrate.
2. What are the benefits of dummy?	Dummy is used to take a look at the project deliverable before it is put to production.
3. What is the purpose of form number?	Form numbers are the reference point to keep pages in order in a book while performing post press operations.
4. Why do we mention front lay in a layout?	Front lay is the reference point of entrance into the printing machine, it helps establish paper grain amongst other things
5. Is dummy prepared for color approval?	Yes but more than that it is prepared for the overall approval of all attributes of the product including finished size, shape etc.
6. Can GSM and thickness be compared with a dummy?	Not always, mostly dummy is printed on a different substrate than the finished job
7. Who prepares the dummy?	The design department in the printing press prepares the dummy.

Self-Assessment

(MCQs)

Please mark the correct one from the given options. You can check your answer with the Answer Key at the end of this module

Q 1: Which of the following is the biggest paper size?

- a) A1
- b) A2
- c) A3
- d) A4

Q 2: Which of the following is the smallest paper size?

- a) A1
- b) A2
- c) A3
- d) A4

Q 3: Where is the vertical center fold located in a layout?

- a) Left side
- b) Right Side
- c) Center
- d) Outside

Q 4: Alignment mark is outside the image area

- a) True
- b) False

Q 5: To align the sheet on the feed table with the required accuracy, it is usually aligned at:

- a) Registration marks
- b) Two front lays and one side lay
- c) Base line
- d) Image area

Q 6: In printing terms what does two-up, four-up and multiple-up means?

- a) Steps before 7-up
- b) Colors on a printing press
- c) Plates in the job
- d) The way art work is designed to print more than one image at the same time

Q 7: What are test targets that are used to measure print color attributes?

- a) Color bar
- b) Measuring scale
- c) GSM cutter
- d) Weighing scale

Q 8: Grey balance target is a type of?

- a) Color bar
- b) Measuring scale
- c) GSM cutter
- d) Weighing scale

Q 9: Full bleed layout leaves no surrounding margin?

- a) True
- b) False

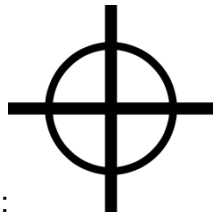

Q 10: What is this: ?

- a) Color bar
- b) Registration mark
- c) Target mark
- d) Bleed mark

Answer Key

MCQ No.	Correct Answer
1	A
2	D
3	C
4	A
5	B
6	D
7	A
8	A
9	A
10	B

National Vocational and Technical Training Commission (NAVTTTC)

 Plot 38, Kirthar Road, Sector H-9/4, Islamabad, Pakistan

 +92 51 9044 322

 +92 51 9044 322

 info@navttc.org

 www.navttc.org